

KANSTOR INC.

100% Newfoundland owned & operated!

TOLL FREE: 877-364-4994

FAX: (709) 364-5116

BUSINESS: (709) 364-4999

E-mail: info@kanstor.com

www.kanstor.com



Material Handling & Industrial Products



Catalogue K35

HI-STAK PLASTIC BINS

- Innovative stacking design allows for greater visibility and easier access to contents
- Distortion-free from -40°C to 120°C
- Unaffected by oil, alkaline and most acids
- Ideal in production or for store display
- Included with each bin: I.D. card with clear plastic shield, four riser legs and connector clip



Connector clip allows for back-to-back mounting

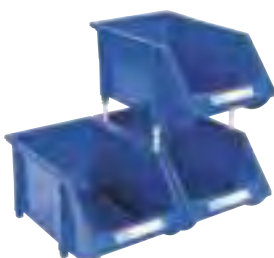

1" riser legs increase loading capacity and stability



Inclined faceplate with removable label and protector

Built-in extrusions allow side-by-side interlock

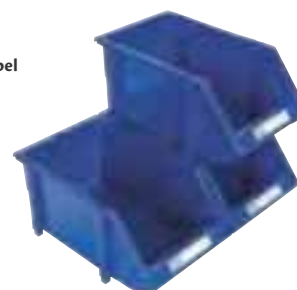

Stackable using built-in feet

Model No.				Dimensions				Qty /Case	Wt. lbs.
Blue	Yellow	Green	Red	W"	x D"	x H"			
CB260	CB261	CC234	CC242	4 13/16	x 7 1/8	x 3 3/16	60	0.10	
CB262	CB263	CC235	CC243	5 7/8	x 9 13/16	x 4 11/16	36	0.15	
CB264	CB265	CC236	CC244	8 3/16	x 14	x 6 3/16	18	0.35	
CC239	CC240	CC237	CC245	7 7/8	x 17 11/16	x 7	12	0.55	
CB266	CB267	CC238	CC246	11 13/16	x 17 11/16	x 7	8	0.60	

Add 1 inch to overall height when stacking on legs

WIRE SHELVING UNITS WITH STORAGE BINS



Same great features as the Kleton chromate wire shelving, but with the added convenience of heavy-duty storage bins.

- Adjustable chromate wire shelves
- Wire shelving resists corrosion and provides greater visibility to stored parts
- Wire shelves prevent build up of dust and dirt
- Bins are unaffected by oil, alkaline, and most acids
- Ideal in production or for parts storage
- Stationary units total capacity should not exceed 2000 lbs.
- NSF Certified (wire shelving units only)
- Assembly required



RL815



RL820

Model No.	Shelving Dim. W" x D" x H"	No. of Shelves	Bin Dimensions				No. of Bins	Colour
			W"	x D"	x H"			
RL815	36 x 14 x 74	8	8 3/16	x 14	x 6 3/16	28	Blue	
RL816	36 x 14 x 74	8	8 3/16	x 14	x 6 3/16	28	Yellow	
RL817	36 x 14 x 74	8	8 3/16	x 14	x 6 3/16	28	Green	
RL818	36 x 14 x 74	8	8 3/16	x 14	x 6 3/16	28	Red	
RL819	36 x 18 x 74	8	7 7/8	x 17 11/16	x 7	28	Blue	
RL820	36 x 18 x 74	8	7 7/8	x 17 11/16	x 7	28	Yellow	
RL821	36 x 18 x 74	8	7 7/8	x 17 11/16	x 7	28	Green	
RL822	36 x 18 x 74	8	7 7/8	x 17 11/16	x 7	28	Red	
RL827	48 x 18 x 74	8	7 7/8	x 17 11/16	x 7	28	Blue	
			11 13/16	x 17 11/16	x 7	7	Blue	
RL828	48 x 18 x 74	8	7 7/8	x 17 11/16	x 7	28	Yellow	
			11 13/16	x 17 11/16	x 7	7	Yellow	
RL829	48 x 18 x 74	8	7 7/8	x 17 11/16	x 7	28	Green	
			11 13/16	x 17 11/16	x 7	7	Green	
RL830	48 x 18 x 74	8	7 7/8	x 17 11/16	x 7	28	Red	
			11 13/16	x 17 11/16	x 7	7	Red	
RL831	48 x 18 x 74	8	7 7/8	x 17 11/16	x 7	7	Blue	
			11 13/16	x 17 11/16	x 7	21	Blue	
RL832	48 x 18 x 74	8	7 7/8	x 17 11/16	x 7	7	Yellow	
			11 13/16	x 17 11/16	x 7	21	Yellow	
RL833	48 x 18 x 74	8	7 7/8	x 17 11/16	x 7	7	Green	
			11 13/16	x 17 11/16	x 7	21	Green	
RL834	48 x 18 x 74	8	7 7/8	x 17 11/16	x 7	7	Red	
			11 13/16	x 17 11/16	x 7	21	Red	
RL839	36 x 18 x 74	8	7 7/8	x 17 11/16	x 7	7	Blue	
			11 13/16	x 17 11/16	x 7	14	Blue	
RL840	36 x 18 x 74	8	7 7/8	x 17 11/16	x 7	7	Yellow	
			11 13/16	x 17 11/16	x 7	14	Yellow	
RL841	36 x 18 x 74	8	7 7/8	x 17 11/16	x 7	7	Green	
			11 13/16	x 17 11/16	x 7	14	Green	
RL842	36 x 18 x 74	8	7 7/8	x 17 11/16	x 7	7	Red	
			11 13/16	x 17 11/16	x 7	14	Red	

BINS

QUANTUM™ BINS

- Heavy-duty, virgin, high density polypropylene/polyethylene
- Autoclavable up to 250°F
- Large multiple label slots
- Stackable
- Optional dividers and clear windows available for most units
- Hangs on louvered panels, rails and carts
- Jumbo bins cannot hang on louvered panels or rail systems
- Jumbo bins have a stack capacity of up to 100 lbs. and can stack up to six bins high
- Mobile bins come with four swivel 3" casters with brakes
- Made of FDA approved materials



		Model No.					Mfg. No.	Outside Dimensions				Qty /Case	Bin load Cap. lbs.
Black	Blue	Yellow	Red	Ivory	Green	W"		x	D"	x	H"		
CC975	CB739	CB741	CB744	CB745	CC264	QUS 200	4 1/8	x	5	x	3	24	8
CC976	CB747	CB750	CB751	CB753	CC265	QUS 210	4 1/8	x	5 3/8	x	3	24	10
CC977	CB756	CB757	CB759	CB762	CC266	QUS 220	4 1/8	x	7 3/8	x	3	24	10
CF376	CF377	CF378	CF379	CF380	CF381	QUS 221	6	x	9 1/4	x	5	12	20
CD276	CD249	CD262	CD263	CD264	CD265	QUS 224	4 1/8	x	10 7/8	x	4	12	30
CC978	CB763	CB765	CB766	CB768	CC267	QUS 230	5 1/2	x	10 7/8	x	5	12	30
CC974	CC971	CC972	CC973	CC990	CC970	QUS 234	5 1/2	x	14 3/4	x	5	12	50
CC980	CB775	CB777	CB778	CB780	CC269	QUS 235	11	x	10 7/8	x	5	6	50
CC576	CB781	CB783	CB784	CB786	CC270	QUS 239	8 1/4	x	10 3/4	x	7	6	50
CC577	CB787	CB789	CB790	CB792	CC271	QUS 240	8 1/4	x	14 3/4	x	7	12	60
CF382	CF383	CF384	CF385	CF386	CF387	QUS 241	8 1/4	x	13 5/8	x	6	12	60
CF388	CF389	CF390	CF391	CF392	CF393	QUS 242	8 1/4	x	13 5/8	x	8	12	60
CC983	CC282	CC283	CC284	CC285	CC286	QUS 245	16 1/2	x	10 7/8	x	5	6	60
CC578	CB794	CB795	CB796	CB797	CC272	QUS 250	16 1/2	x	14 3/4	x	7	6	75
CC579	CB798	CB800	CB801	CB802	CC273	QUS 255	11	x	16	x	8	4	75
CC580	CB803	CB804	CB806	CB807	CC274	QUS 260	11	x	18	x	10	4	75
CC581	CC287	CC288	CC289	CC290	CC291	QUS 265	8 1/4	x	18	x	9	6	60
CC582	CB808	CB809	CB810	CB811	CC275	QUS 270	16 1/2	x	18	x	11	3	75
CD674*	CD669*	CD670*	CD671*	CD673*	CD672*	QUS 275MOB	16 1/2	x	18	x	14	3	-

JUMBO 24" DEEP ULTRA BINS (do not hang on louvered panels or rail systems)													
-	CD545	CD547	CD546	-	-	QUS950	8 1/4	x	23 7/8	x	7	6	-
-	CD548	CD550	CD549	-	-	QUS951	8 1/4	x	23 7/8	x	9	6	-
-	CD551	CD553	CD552	-	-	QUS952	11	x	23 7/8	x	7	4	-
-	CD554	CD556	CD555	-	-	QUS953	11	x	23 7/8	x	10	4	-
-	CD557	CD559	CD558	-	-	QUS954	16 1/2	x	23 7/8	x	11	1	-
-	CD560	CD562	CD561	-	-	QUS955	18 1/4	x	23 7/8	x	12	1	-

DIVIDERS ONLY

Depth Model No.	Clear Window Model No.
CB824	-
CB825	-
CB826	-
CF501	CF560
CD250	CD266
CB829	CB814
CC569	CB814
CB829	CB815
CB830	CB818
CB831	CB818
CF394	CF396
CF395	CF397
CC297	CC300
CB831	CB819
CB833	CB820
CB834	CB821
CC298	CC301
CB835	CB822
CB835	CB822

JUMBO DIVIDERS ONLY	
CD563	CD569
CD564	CD570
CD563	CD571
CD566	CD572
CD567	CD573
CD568	CD574

* Mobile unit

OPEN HOPPER STORAGE SHELF UNITS

QUS 239 SERIES

- 28 QUS 239 Series bins 8 1/4" W x 10 3/4" D x 7" H
- Eight heavy-duty grey enamel shelves
- 36" W x 12" D x 76" H
- Cap.: 630 lbs. per shelf
- Shipped knocked down



CF118

QUS 240 SERIES

- 28 QUS 240 Series bins 8 1/4" W x 14 3/4" D x 7" H
- Eight heavy-duty grey enamel shelves
- 36" W x 12" D x 76" H
- Cap.: 630 lbs. per shelf
- Shipped knocked down



CF126

QUS 250 SERIES

- 14 QUS 250 Series bins 16 1/2" W x 14 3/4" D x 7" H
- Eight heavy-duty grey enamel shelves
- 36" W x 12" D x 76" H
- Cap.: 630 lbs. per shelf
- Shipped knocked down



CF132

QUS 240 & 230 SERIES

- 8 QUS 240 Series bins 8 1/4" W x 14 3/4" D x 7" H
- 36 QUS 230 Series bins 5 1/2" W x 10 7/8" D x 5" H
- Nine heavy-duty grey enamel shelves
- 36" W x 12" D x 76" H
- Cap.: 630 lbs. per shelf
- Shipped knocked down



CF135

Black	Blue	Yellow	Red	Ivory	Green	Description	No. of Shelves
QUS 239 SERIES BINS SHELF UNIT							
CF176	CF118	CF119	CF120	CF121	CF122	Starter	8
CF180	CF140	CF141	CF142	CF143	CF144	Add-On	8
QUS 240 SERIES BINS SHELF UNIT							
CF178	CF123	CF124	CF125	CF126	CF127	Starter	8
CF182	CF150	CF151	CF152	CF153	CF154	Add-On	8

Black	Blue	Yellow	Red	Ivory	Green	Description	No. of Shelves
QUS 250 SERIES BINS SHELF UNIT							
CF177	CF128	CF129	CF130	CF131	CF132	Starter	8
CF181	CF145	CF146	CF147	CF148	CF149	Add-On	8
QUS 240 & 230 SERIES BINS SHELF UNIT							
CF179	CF133	CF134	CF135	CF136	CF137	Starter	9
CF183	CF175	CF155	CF156	CF157	CF158	Add-On	9

PLASTIC BINS

- Designed to hang from bin racks, panels, rails and carts
- Bins reduce and control inventories, shorten assembly times and minimise parts handling
- Reinforced ribs, on both sides, prevent bins from spreading under loads
- Unaffected by weak acids and alkalis
- Stackable
- Seven available colours allow for colour coding
- Recycled plastic bins are made from 100% post consumer material, available in black only

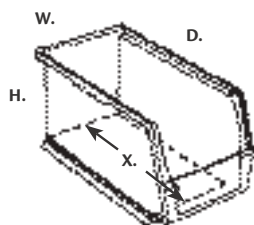

Bin Model No.							Mfg. No.	Outside Dimensions				Inside Dimensions				Bin Load Cap.** lbs.	Qty /Case	Wt. lbs.	Dividers Model No.				
Blue	Red	Yellow	Green	Stone	Clear	Black		W"	x	D"	x	H"	W"	x	D"					x	H"	x	X*"
CB093	CB094	CB095	CB663	CB664	CF427	CF434	30-210	4 1/8	x	5 3/8	x	3	3 7/16	x	4 3/4	x	2 13/16	x	4	10	24	0.2	CB124
CB096	CB097	CB098	CB665	CB666	CF428	CF435	30-220	4 1/8	x	7 3/8	x	3	3 7/16	x	6 3/4	x	2 13/16	x	6	10	24	0.3	CB125
CB099	CB100	CB101	CB667	CB668	CF429	CF436	30-230	5 1/2	x	10 7/8	x	5	4 3/8	x	10 1/4	x	4 3/4	x	9	30	12	0.8	CD513
CB102	CB103	CB104	CB669	CB670	CF430	CF437	30-235	11	x	10 7/8	x	5	10	x	10 1/4	x	4 3/4	x	9	50	6	1.5	CD514
CB105	CB106	CB107	CB671	CB672	CF431	CF438	30-239	8 1/4	x	10 3/4	x	7	6 9/16	x	10	x	6 3/4	x	8	50	6	1.5	CB128
CB108	CB109	CB110	CB673	CB674	CF432	CF439	30-240	8 1/4	x	14 3/4	x	7	6 9/16	x	14	x	6 3/4	x	12	60	12	2.0	CB129
CB111	CB112	CB113	CB675	CB676	CF433	CF440	30-250	16 1/2	x	14 3/4	x	7	14 3/4	x	14	x	6 3/4	x	12	75	6	3.5	CF023

* Int. Dim. X = length of bottom.

GIANT STACKING CONTAINERS

- Designed for multiple applications in recycling, storing parts, tools and warehouse items
- Will stack up to six high creating sturdy, tall storage systems
- Large grip side handles
- Extra thick side walls with reinforcing ribs allow for 100-lb. stack capacity per bin
- Six 1/4" drill holes in bottom allow for drainage
- Outside dimensions: 15 1/4" L x 19 7/8" W x 12 7/16" H
- Optional clear window and labels are available



Model No.					Mfg. No.	Qty /Case
Grey	Blue	Ivory	Black	Red		
CB838	CB839	CB841	CB842	CC305	QGH700	3

GIANT STACK CONTAINER SHELF UNITS

- Includes 10 QGH700 storage bins and heavy-duty grey enamel shelves
- 42" W x 18" D x 76" H
- Capacity: 500 lbs. per shelf
- Shipped knocked down



Model No.					Description	No. of Shelves
Grey	Blue	Ivory	Black	Red		
CF056	CF057	CF059	CF060	CF066	Starter	6
CF061	CF062	CF064	CF065	CF067	Add-On	6

BIN BUDDY™ & TRI-DEX™ LABEL HOLDERS

- Clear self-adhesive backing adheres to any plastic or metal container
- Clear bar code compatible window protects label from dirt and moisture
- Tri-Dex™ label holders snap into bin slots protecting label or barcode
- Includes a set of laser/ink jet compatible labels, 25/pack
- Extra refill labels are also available, sold 50/pack

Bin not included



OK113

Model No.	Mfg. No.	Dimensions"	Description	Refill Labels
OF212	BB-13	1 x 3	Bin Buddy™, Top/Bottom load, Self Adhesive	OF216
OF210	BB-35	3 x 5	Bin Buddy™, Side Load, Self Adhesive	OF214
OK113	TR-0813	13/16 x 3	Tri-Dex™, Ideal for Shelf Bins	OK118
OK114	TR-1300	1 x 3	Tri-Dex™, Ideal for Bin Series 30-210, 30-220	OK119
OK116	TR-1754	1 3/4 x 4	Tri-Dex™, Ideal for Bin Series 30-230, 30-250	OK121

BINS CARTS

- All-welded bin cart
- Work surface made of 14-gauge steel
- **Includes:** 20 bins of various size, bolted-on 5" non-marking casters and two louvered panels
- Capacity: 1000 lbs.
- Durable Kleton blue enamel finish

BINS SUPPLIED

Bin Qty	Bin Dimensions			
	W"	x	D"	x H"
16	8 1/4	x	14 3/4	x 7
4	16 1/2	x	14 3/4	x 7



CB367

Model No.	Description	Dimensions			Wt. lbs.	
		W"	x	D"		x H"
CB365	Cart Only	24	x	38 1/2	x 36 1/2	95

CART/BIN COMBINATION

Blue	Red	Yellow	Green	Stone	Bin Qty	Wt. lbs.
CB366	CB367	CB368	CB689	CB690	20	133

BINS & SUPPORT RACKS

METAL BIN SUPPORT RACKS

- Louvered bin panels can be wall-mounted, attached to back of shelving, mounted on benches, carts, inside cabinets, fastened to slotted angle components or used for service truck interiors
- Bins are easily removed, refilled and replaced
- Each heavy-duty panel is 16-gauge cold-rolled steel
- Slotted holes 3/4" L x 3/8" W at 6" centres simplify installation
- Kleton grey powder coated
- **Installation note:** Panels must be securely fastened to materials of adequate load bearing strength



BIN QUANTITY TABLE

Quantity of identical plastic bins that fit CF412 Panel

Bins not included

Combined Panel Height 35 3/4" Wide	Model No.						
	Bin CB093	Bin CB096	Bin CB099	Bin CB102	Bin CB105	Bin CB108	Bin CB111
1 Panel = 19" H	32	32	18	9	8	8	4
2 Panels = 37" H	72	72	36	18	18	16	8
3 Panels = 55" H	104	104	54	27	28	28	14
4 Panels = 73" H	144	144	72	36	36	36	18

For CF411 Panel, use 1/2 of bin quantities shown above

Model No.	Panel Dimensions W" x H"	Wt. lbs.
CF411	18 x 19	6
CF412	36 x 19	12



BENCH LOUVERED RACKS

- All-welded louvered bench rack
- Provides tool and storage for assembly or repair operations when combined with plastic parts bin
- Durable Kleton blue enamel finish

36" FREE STANDING RACKS

- Free standing unit made of 1" square tube frame
- May be placed on any flat surface near a worksite without the need for bolts or fasteners

72" BOLT-ON RACKS

- Constructed of 1 1/4" square tube frame
- Designed to be permanently installed on a 72" wide workbench



Model No.	Rack Type	Dimensions W" x D" x H"	Wt. lbs.
CB363	Free Standing	36 x 10 x 22	22
CB364	Bolt-On	72 x 15 x 40	95

STATIONARY BIN RACKS

- Designed to be permanently installed to the floor
- All-welded stationary bin racks
- Constructed of 1 1/4" square tube frame
- Choose from either single or double-sided racks to meet your storage needs
- Durable Kleton blue enamel finish
- Includes 28 or 56 bins
- 8 1/4" W x 14 3/4" D x 7" H
- Shipped all-welded



Model No.	Description	Rack Type	Dimensions W" x D" x H"	Wt. lbs.
CB373	Rack Only	Single	36 x 12 x 61	60
CB653	Rack Only	Double	36 x 24 x 61	100

RACK/BIN COMBINATION

Blue	Red	Yellow	Green	Stone	Rack Type	Bin Qty	Capacity lbs.
CB654	CB655	CB656	CB685	CB686	Single	28	1680
CB370	CB371	CB372	CB687	CB688	Double	56	3360

ACCESSORIES

Model No.	Description
CC165	Round Hook, 6"
CC166	Round Hook, 12"
CC167	Square Hook, 6"
CC168	Square Hook, 12"



MOBILE BIN RACKS

- Ideal for transportation of small parts
- All-welded mobile bin rack
- **Single** includes 36 bins
- 5 1/2" W x 10 7/8" D x 5" H, 3" casters and two louvered panels
- **Double cart** includes 96 bins of various sizes, bolted on 5" non-marking casters and six louvered panels
- Capacity: 800 lbs. single sided and 1000 lbs. double sided
- Durable Kleton blue enamel finish



BINS SUPPLIED

Qty	Bin Dimensions W" x D" x H"
36	5 1/2 x 10 7/8 x 5

Model No.	Description	Rack Type	Dimensions W" x D" x H"	Wt. lbs.
CB359	Rack only	Single	36 x 16 x 46	60
CB649	Rack only	Double	36 x 24 x 63	120

RACK/BIN COMBINATION

Blue	Red	Yellow	Green	Stone	Rack Type	Bin Qty	Wt. lbs.
CB650	CB651	CB652	CB681	CB682	Single	36	83
CB089	CB090	CB091	CB683	CB684	Double	96	187

DEEP DOOR COMBINATION CABINETS

- All-welded heavy-duty 16-gauge, combination bin/shelf cabinet
- 4" deep hinged doors
- Unique padlock hasp helps prevent access with bolt cutters
- Powder coated Kleton grey finish
- Padlock sold separately

A. 84 BIN CABINETS

- Four reinforced 16-gauge main adjustable shelves with 500-lb. capacity per shelf
- Incorporates louvered bin hanging panels welded into the cabinets doors

CABINET ONLY

Model No.	Description	Dimensions				Wt. lbs.
		W"	x	D"	x H"	
CB442	Cabinet Only	38	x	24	x 72	324
FB025	Extra Shelf	38	x	18	x 1	18

CABINET WITH BINS

Model No.					Description	Wt. lbs.
Blue	Red	Yellow	Green	Stone		
CB446	CB477	CB448	CB693	CB694	Cabinet and Plastic Bins	341

BINS SUPPLIED

Bin Qty	Bin Dimensions				Capacity lbs.
	W"	x	D"	x H"	
84	4 1/8	x	5 3/8	x 3	10

B. 96 BIN CABINETS

- Two reinforced 16-gauge main adjustable shelves with 500-lb. capacity per shelf
- Incorporates louvered bin hanging panels welded to the cabinet's back and doors

CABINET ONLY

Model No.	Description	Dimensions				Wt. lbs.
		W"	x	D"	x H"	
FH820	Cabinet Only	38	x	24	x 72	316
FB025	Extra Shelf	38	x	18	x 1	18

CABINET WITH BINS

Model No.					Description	Wt. lbs.
Blue	Red	Yellow	Green	Stone		
CF371	CF372	CF373	CF374	CF375	Cabinet and Plastic Bins	359

BINS SUPPLIED

Bin Qty	Bin Dimensions				Capacity lbs.
	W"	x	D"	x H"	
84	4 1/8	x	5 3/8	x 3	10
12	5 1/2	x	10 7/8	x 5	30

C. 98 BIN CABINETS

- Two reinforced 16-gauge main adjustable shelves with 500-lb. capacity per shelf
- Incorporates louvered bin hanging panels welded to the cabinet's back and doors

CABINET ONLY

Model No.	Description	Dimensions				Wt. lbs.
		W"	x	D"	x H"	
FH820	Cabinet Only	38	x	24	x 72	316
FB025	Extra Shelf	38	x	18	x 1	18

CABINET WITH BINS

Model No.					Description	Wt. lbs.
Blue	Red	Yellow	Green	Stone		
CF355	CF356	CF354	CF357	CF358	Cabinet and Plastic Bins	385

BINS SUPPLIED

Bin Qty	Bin Dimensions				Capacity lbs.
	W"	x	D"	x H"	
48	4 1/8	x	5 3/8	x 3	10
36	4 1/8	x	7 3/8	x 3	10
8	8 1/4	x	14 3/4	x 7	60
6	16 1/2	x	14 3/4	x 7	75



D. 118 BIN CABINETS

- Incorporates louvered bin hanging panels welded to the cabinet's back and doors

CABINET ONLY

Model No.	Description	Dimensions				Wt. lbs.
		W"	x	D"	x H"	
CB441	Cabinet Only w/o Shelves	38	x	24	x 72	316

CABINET WITH BINS

Model No.					Description	Wt. lbs.
Blue	Red	Yellow	Green	Stone		
CB443	CB444	CB445	CB691	CB692	Cabinet and Plastic Bins	385

BINS SUPPLIED

Bin Qty	Bin Dimensions				Capacity lbs.
	W"	x	D"	x H"	
42	4 1/8	x	5 3/8	x 3	10
42	4 1/8	x	7 3/8	x 3	10
18	5 1/2	x	10 7/8	x 5	30
12	8 1/4	x	14 3/4	x 7	60
4	16 1/2	x	14 3/4	x 7	75

SHELF BINS

SHELF BINS

- Economical way to store and display parts and components
- Durable polypropylene
- Designed for use on 12", 18" and 24" deep shelving, or vertical storage and retrieval units
- Shelf bins "nest" when empty
- Bin cups and dividers available
- Manufactured from FDA approved polypropylene

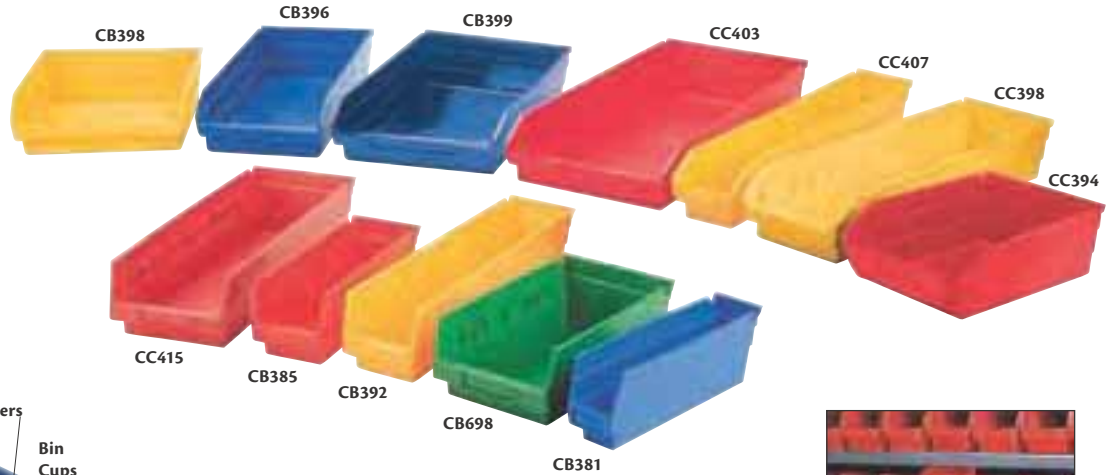

The special built-in hanglock catches the underside of the shelf above, allowing each bin to be tilted out for complete access.

Blue		Red		Model No.		Mfg. No.		Outside Dimensions				Inside Dimensions				Qty /Case	Dividers, up to 7 per bin	Bin Cups Per Bin			
CB381	CB382	CB383	N/A	CB696	30-110	2 3/4	x	11 5/8	x	4	1 5/8	x	10 1/4	x	4	24	N/A	CB379	CB380	CD036	CD041
CB384*	CB385*	CB386*	N/A	CB697*	30-120	4 1/8	x	11 5/8	x	4	3	x	10 1/4	x	4	24	CB420	5	2	N/A	N/A
CB393*	CB394*	CB395*	N/A	CB698*	30-130	6 5/8	x	11 5/8	x	4	5 1/2	x	10 1/4	x	4	12	CB421	9	4	N/A	N/A
CC393	CC394	CC395	CF531	CD023	QSB107	8 3/8	x	11 5/8	x	4	7 1/2	x	10 3/4	x	3 7/8	20	CB867	N/A	N/A	12	4
CC396	CC397	CC398	CF532	CD026	QSB109	11 1/8	x	11 5/8	x	4	10 3/8	x	10 3/4	x	3 7/8	8	CB869	N/A	N/A	18	6
CB390*	CB391*	CB392*	N/A	CB699*	30-128	4 1/8	x	17 7/8	x	4	3	x	16 1/2	x	4	12	CF021	8	3	N/A	N/A
CB396*	CB397*	CB398*	N/A	CB700*	30-138	6 5/8	x	17 7/8	x	4	5 1/2	x	16 1/2	x	4	12	CB421	15	6	N/A	N/A
CC399	CC400	CC401	CF533	CD029	QSB108	8 3/8	x	17 7/8	x	4	7 1/2	x	16 1/2	x	3 7/8	10	CB867	N/A	N/A	19	6
CC402	CC403	CC404	CF534	CD032	QSB110	11 1/8	x	17 7/8	x	4	10 3/8	x	16 3/8	x	3 7/8	8	CB869	N/A	N/A	29	9
CC405	CC406	CC407	CF535	CD045	QSB105	4 1/8	x	23 5/8	x	4	3 1/4	x	22 1/4	x	3 7/8	8	CB861	N/A	N/A	13	4
CC408	CC409	CC423	CF536	CD048	QSB106	6 5/8	x	23 5/8	x	4	5 1/2	x	22 1/4	x	3 7/8	8	CB862	N/A	N/A	21	8
CC411	CC412	CC413	CF537	CD051	QSB114	8 3/8	x	23 5/8	x	4	7 1/2	x	22 1/4	x	3 7/8	6	CB867	N/A	N/A	24	8
CC414	CC415	CC416	CF538	CD054	QSB116	11 1/8	x	23 5/8	x	4	10 3/8	x	22 1/4	x	3 7/8	6	CB869	N/A	N/A	35	16

* Two full width adjustable/removable dividers included

BIN DIVIDERS

Model No.	Mfg. No.	Width"	Qty/Case
CB420	40-120	2 7/8	24
CF021	40-128	3	72
CB861	DSB101	4 1/8	50
CB421	40-130	5 1/2	24
CB862	DSB102	6 5/8	50
CB867	DSB107	8 1/8	50
CB869	DSB109	11 1/8	50

BIN CUPS

Model No	Mfg. No.	Colour	Dimensions
CB379	30-101	White	3 1/4" x 2"
CB380	30-102	White	5" x 2 3/4"
CD036	QBC111	Yellow	3 1/4" x 1 3/4"
CD041	QBC112	Yellow	5 1/8" x 2 3/4"

EXTENDED LABEL HOLDERS, 24 PER BOX

Model No	Mfg. No.	Colour	Angle
CF398	ELH410	Black	10°
CF399	ELH415	Black	45°

RECYCLED SHELF BINS

- Manufactured from recycled 100% post consumer, high density polyethylene
- Available in black only

Model No.	Mfg. No.	Outside Dimensions				Qty /Case	Dividers* Model No.	
		W"	x	D"	x			H"
CF441	30-110BLK	2 3/4	x	11 5/8	x	4	48	N/A
CB850	QSB 101 BR	4 1/8	x	11 5/8	x	4	36	CB861
CB851	QSB 102 BR	6 5/8	x	11 5/8	x	4	30	CB862
CF442	30-128 BLK	4 1/8	x	17 7/8	x	4	24	CB420
CB954	QSB 104 BR	6 5/8	x	17 7/8	x	4	20	CB862
CB854	QSB 105 BR	4 1/8	x	23 5/8	x	4	8	CB861
CB855	QSB 106 BR	6 5/8	x	23 5/8	x	4	8	CB862
CB857	QSB 108 BR	8 3/8	x	17 7/8	x	4	10	CB867
CB860	QSB 114 BR	8 1/8	x	23 5/8	x	4	6	CB867
CC304	QSB 116B	11 1/8	x	23 5/8	x	4	6	CB869
CC241	QGH 700 BR	19 7/8	x	15 1/4	x	12 7/16	1	N/A

* Dividers are made of non-recycled polyethylene

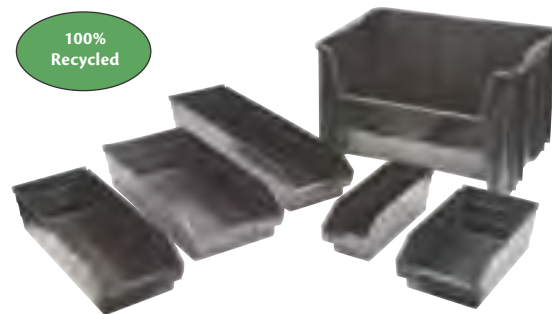

SHELF BINS & CONTAINERS

EURO DRAWERS

- Heavy-duty design for efficient organization of heavy parts, supplies, tools or equipment
- Injection molded from virgin grade high-impact polystyrene
- 12-gauge thick wall
- Completely waterproof
- Oil and chemical-resistant
- Smooth front curved pull handle has ample room for pressure sensitive identification labels or bar codes
- Front handle has 3/4" opening
- Full width back ledge ensures spill free use

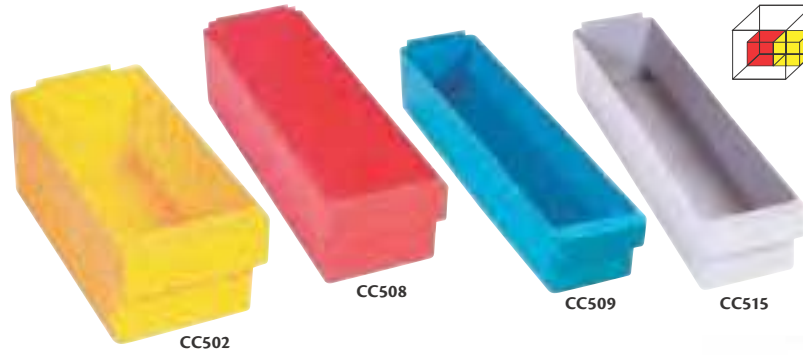

Blue	Model No.			Mfg. No.	Outside Dimensions			Qty /Case	Divider Model No.
	Grey	Red	Yellow		W" x D" x H"				
CE289	CE291	CE292	CE290	QED401	5 9/16	x 11 5/8	x 2 5/8	24	CE309
CE293	CE295	CE296	CE294	QED501	3 3/4	x 11 5/8	x 4 5/8	24	CC518
CC501	CC503	CC504	CC502	QED601	5 9/16	x 11 5/8	x 4 5/8	24	CC517
CC505	CC507	CC508	CC506	QED602	5 9/16	x 17 5/8	x 4 5/8	24	CC517
CC509	CC511	CC512	CC510	QED603	5 9/16	x 23 7/8	x 4 5/8	12	CC517
CC513	CC515	CC516	CC514	QED604	3 3/4	x 17 5/8	x 4 5/8	24	CC518
CE305	CE307	CE308	CE306	QED606	8 3/8	x 17 5/8	x 4 5/8	24	CE312
CE297	CE299	CE300	CE298	QED701	8 3/8	x 11 5/8	x 4 5/8	24	CE312
CE301	CE303	CE304	CE302	QED801	11 1/8	x 11 5/8	x 4 5/8	12	CE314

Add dividers to Euro Drawers for additional storage possibilities!



EURO DRAWER CLOSED SHELF UNITS

- 13 heavy-duty grey enamel shelves
- Capacity: 630 lbs. per shelf
- Shipped knocked down



INCLUDES:

- 72 QED601 Series Euro drawers, 5 9/16" W x 11 5/8" D x 4 5/8" H
- Dimensions: 36" W x 12" D x 76" H

Model No.				Description	No. of Shelves
Blue	Yellow	Grey	Red		
CF102	CF103	CF104	CF105	Starter	13
CF159	CF160	CF161	CF162	Add-On	13

- 72 QED602 Series Euro drawers 5 9/16" W x 17 5/8" D x 4 5/8" H
- Dimensions: 36" W x 18" D x 76" H

Model No.				Description	No. of Shelves
Blue	Yellow	Grey	Red		
CF106	CF107	CF108	CF109	Starter	13
CF163	CF164	CF165	CF166	Add-On	13

- 108 QED604 Series Euro drawers 3 3/4" W x 17 5/8" D x 4 5/8" H
- Dimensions: 36" W x 18" D x 76" H

Model No.				Description	No. of Shelves
Blue	Yellow	Grey	Red		
CF110	CF111	CF112	CF113	Starter	13
CF167	CF168	CF169	CF170	Add-On	13

- 72 QED603 Series Euro drawers 5 9/16" W x 23 7/8" D x 4 5/8" H
- Dimensions: 36" W x 24" D x 76" H

Model No.				Description	No. of Shelves
Blue	Yellow	Grey	Red		
CF114	CF115	CF116	CF117	Starter	13
CF171	CF172	CF173	CF174	Add-On	13

JUMBO PLASTIC CONTAINERS

- Extra-large size provides massive amount of storage capacity
- Guaranteed unbreakable and distortion-free from -40°C to 120°C
- Unaffected by oil, alkaline, and most acids
- Nesting design allows for minimal storage space when not in use
- Stackable for added space savings, up to four high
- Outside Dimensions: 15 1/2" W x 25" D x 13" H
- Capacity: 200 lbs.



Model No.	Colour	Model No.	Colour
CF328	Blue	CF329	Green
CF330	Yellow	CF327	Red

STACK-N-NEST® STORAGE BINS

- Great for storing, assembling and transporting small parts, components and finished goods
- Designed for maximum efficiency and utility
- Set together one way they stack and the other way they nest
- May be used on shelving or stacked up
- Heavy-duty design allows higher stacking
- In the plant, use the same bin for storage, handling, and assembly, no need to transfer contents



Model No.	Colour	Outside Dimensions			Wt. lbs.
		W" x D" x H"			
CC890	Blue	12 1/4 x 15 1/4 x 6	2		
CC891	Red	12 1/4 x 15 1/4 x 6	2		
CC892	Yellow	12 1/4 x 15 1/4 x 6	2		

FIBREBOARD BINS & RACKS

CORRUGATED PARTS BINS & DIVIDERS

- Economical standard duty bins constructed of durable corrugated fibreboard
- Ideal for storing any loose small parts
- Assembled easily without staples or tape, just fold
- Bins are designed to hang from the shelf for hands-free access
- Bin dividers not included
- Qty per case: 100
- Shipped knocked down

12" DEEP PARTS BINS		18" DEEP PARTS BINS		Dimensions W" x H"
Model No.	Ctn. Wt. lbs.	Model No.	Ctn. Wt. lbs.	
CB063	17	CB056	22	2 x 4 1/2
CB064	19	CB057	27	3 x 4 1/2
CB065	20	CB058	30	4 x 4 1/2
CB066	25	CB059	38	6 x 4 1/2
CB067	31	CB060	45	8 x 4 1/2
CB068	36	N/A	-	9 x 4 1/2
CB052	38	CB054	50	10 x 4 1/2
CB053	44	CB055	57	12 x 4 1/2

3 5/8" DEEP REMOVABLE DIVIDERS							
Model No.	Dimensions		Ctn. Wt. lbs.	Model No.	Dimensions		Ctn. Wt. lbs.
	W"	H"			W"	H"	
CB071	1 3/4	4 1/8	7	CB075	7 3/4	4 1/8	22
CB072	2 3/4	4 1/8	9	CB069	9 3/4	4 1/8	27
CB073	3 3/4	4 1/8	10	CB070	11 3/4	4 1/8	31
CB074	5 3/4	4 1/8	14				



Standard Corrugated Bins & Dividers



Removable dividers ease handling

SINGLE-SIDED PICK-RACKS

- Units are free standing, but may be bolted to bench top, floor or wall
- 61" high floor model comes with 48-4" plastic storage bins and 10-6" plastic storage bins or 48-4" corrugated bins and 8-8" corrugated bins
- 21 1/2" high bench model comes with 16-4" plastic storage bins, and 5-6" plastic storage bins or 16-4" corrugated storage bins and 4-8" corrugated storage bins
- Order complete with plastic shelf bins, fibreboard bins or rack only
- Grey enamel finish
- Shipped knocked down

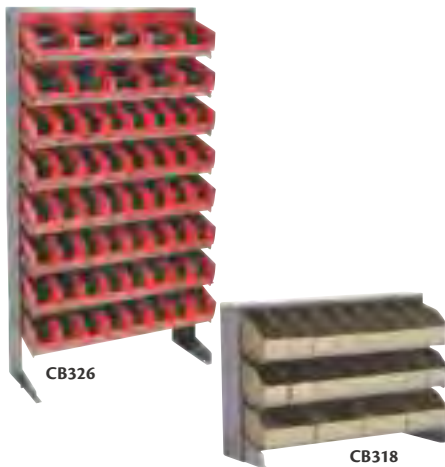

Model No.	Dimensions			Bin Type	Wt. lbs.
	W"	D"	H"		
CB318	32 7/8	12 1/8	21 1/2	Corrugated	22
CB377	32 7/8	12 1/8	21 1/2	Rack Only	17
CB323	33 1/2	12 1/4	61	Corrugated	57
CB378	33 1/2	12 1/4	61	Rack Only	45
Blue	Red	Yellow			
CB320	CB321	CB322	21 1/2	Plastic	25
CB325	CB326	CB327	61	Plastic	65

DOUBLE-SIDED MOBILE PICK-RACKS

- 22-gauge steel rack components mounted on a 26" x 36" dolly
- 3" casters
- Each rack accommodates 96-4" wide storage bins and 20-6" wide bins
- Order complete with plastic shelf bins, fibreboard bins or rack only
- Grey enamel finish
- Shipped knocked down



Model No.	Dimensions			Bin Type	Wt. lbs.
	W"	D"	H"		
CB328	33 1/2	12 1/4	65	Corrugated	139
CB337	33 1/2	12 1/4	65	Rack Only	115
Blue	Red	Yellow			
CB330	CB331	CB332	65	Plastic	155

PARTS STORAGE SHELVING UNITS

- Provides a versatile heavy-duty storage facility for parts storage bins
- 76" high unit comes with 96-4" bins
- 40" high unit comes with 48-4" bins
- Available with plastic shelf bins, fibreboard bins or shelving only
- Grey enamel finish
- Shipped knocked down



Model No.	Dimensions			Bin Type	Wt. lbs.
	W"	D"	H"		
CF048	36	12	40	Corrugated	90
RK203	36	12	40	Shelving Only	80
CF184	36	12	76	Corrugated	163
RK241	36	12	76	Shelving Only	144
Blue	Red	Yellow			
CF049	CF050	CF051	40	Plastic	96
CF053	CF054	CF055	76	Plastic	176

GIANT STACKING CONTAINERS

- Injection-molded from high density polyethylene
- Extra heavy, double wall thickness with interlock preformed lip allows containers to stack securely
- Molded carrying handle on backside
- Molded-in divider and label slots
- Optional windows available
- Can withstand temperatures ranging from -40° to 250°F
- Waterproof, will not rust or corrode
- Unaffected by chemicals and solvents
- Mobile bin comes with two swivel, two rigid 3" casters
- 250-lb. mobile capacity
- 150-lb. stack capacity

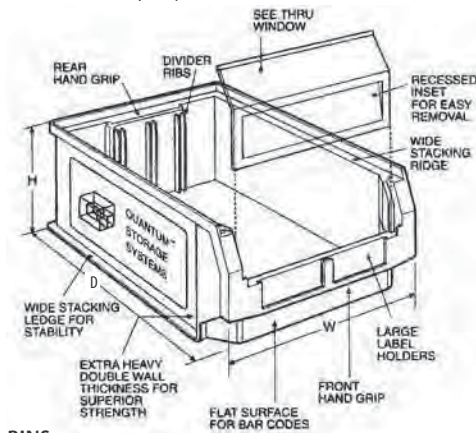

BINS

Model No.				Mfg. No.	Outside Dimensions					Qty /Case
Blue	Green	Red	Yellow		W"	x	D"	x	H"	
CC361	CC362	CC363	CC364	QMS531	12 3/8	x	19 3/4	x	5 7/8	6
CC365	CC366	CC367	CC368	QMS532	12 3/8	x	19 3/4	x	7 7/8	6
CC369	CC370	CC371	CC372	QMS533	12 3/8	x	19 3/4	x	11 7/8	3
CC373	CC374	CC375	CC376	QMS543	18 3/8	x	19 3/4	x	11 7/8	3
CC377*	CC378*	CC379*	CC380*	QMS743	18 3/8	x	29	x	11 7/8	1
CC447*	CC449*	CC448*	CC450*	QMS843MOB**	18 3/8	x	29	x	11 7/8	1

DIVIDER

Model No.	Qty /Case
CC381	6
CC382	6
CC383	3
CC384	3
-	-

WINDOW

Model No.	Qty /Case
CC385	12
CC386	6
CC387	6
CC388	6
-	-

* Includes heavy-duty spread bar for extra strength and support. ** Mobile bins

GIANT OPEN HOPPER BIN SHELVING UNITS

- Dimensions: 42" W x 18" D x 76" H
- Capacity: 500 lbs. per shelf
- Shipped knocked down

Model No.				Description
Red	Blue	Yellow	Green	
SERIES QMS532				
CF072	CF073	CF074	CF075	Starter
CF089	CF090	CF091	CF092	Add-on
SERIES QMS533				
CF080	CF081	CF082	CF083	Starter
CF097	CF098	CF099	CF100	Add-on
SERIES QMS531				
CF188	CF185	CF186	CF187	Starter
SERIES QMS516				
CF189*				Starter

* Mixed colours

SERIES QMS531

- 27-QMS531-green CC362
- 10 heavy-duty grey enamel shelves



CF187

SERIES QMS516

- 4-QMS543-red, CC375
- 3-QMS533-blue, CC369, 6-QMS532-yellow CC368 and 3-QMS531-blue open hopper bins CC361
- Seven heavy-duty grey enamel shelves



CF189

SERIES QMS533

- 15 QMS533-blue, CC369
- Six heavy-duty grey enamel shelves



CF081



CF074

SERIES QMS532

- 21 QMS532-yellow CC368
- Eight heavy-duty grey enamel shelves

STACK-N-NEST CONTAINERS

STACK-N-NEST PLASTIC CONTAINERS

- Polyewton® Stack-N-Nest containers used in general manufacturing, food processing and distribution applications
- Injection-molded from high-impact polyolefins
- Will not rust, rot or corrode, resist damaging effects of oil, most chemical solvents, water and steam
- Stack without lids
- Nest at alternating 180° positions when empty
- Withstands wide temperature variances
- Easily cleaned

Blue & grey bins made of FDA compliant materials



CONTAINERS

Grey	Model No.			Mfg. No.	Outside Dim. Top			Outside Dim. Bottom			Volume cu.ft.	Nesting Ratio	Wt. lbs.	LIDS				
	Red	Blue			L"	x	W"	x	H"	L"				x	W"	Grey	Red	Blue
CA341	CC859	CC868		SN2012-6	20.1	x	13.0	x	6.2	18.5	x	11.5	0.6	2.1:1	2.1	CA334	CC877	CC883
CA344	CC860	CC869		SN2414-8	24.0	x	14.1	x	7.9	21.8	x	11.5	1.1	4:1	3.4	CA337	CC880	CC886
CA342	CC861	CC870		SN2013-12	19.4	x	12.9	x	12.1	17.3	x	10.9	1.3	4:1	3.8	CA335	CC878	CC884
CA343	CC862	CC871		SN2117-12	21.0	x	17.0	x	12.0	18.8	x	15.0	1.8	4:1	5.0	CA336	CC879	CC885
CA346	CC863	CC872		SN2618-10	26.1	x	18.7	x	10.5	24.0	x	15.9	2.1	4:1	5.4	CA339	CC882	CC888
CA348	CC864	CC873		SN3022-6	29.6	x	22.4	x	6.1	28.3	x	21.0	2.1	4:1	4.8	N/A	N/A	N/A
CA347	CC865	CC874		SN2818-10	28.4	x	18.7	x	10.5	26.0	x	15.9	2.3	4:1	5.8	N/A	N/A	N/A
CA345	CC866	CC875		SN2420-13	24.0	x	20.0	x	13.0	21.6	x	17.7	2.7	4:1	6.1	CA338	CC881	CC887
CA349	CC867	CC876		SN3024-15	30.1	x	24.0	x	15.1	27.0	x	21.0	4.7	4.5:1	11.0	N/A	N/A	N/A

STACK-N-NEST PLEXTON CONTAINERS

- Fibreglass wire-reinforced rim containers (for containers 25.3" length and greater)
- Ideal solution for heavy-duty storage, work-in-process and distribution applications
- Can withstand temperatures as low as -60°F and as high as 250°F (continuous)
- Resistant to moisture, chemicals, solvents and most oils
- Capacity: 500 lbs. per container



CONTAINERS

Red	Grey	Mfg. No.	Outside Dim. Top			Inside Dim. Top			Qty /Case	LIDS			DOLLIES	
			L"	x	W"	x	H"	L"		x	W"	Red		Grey
CD179	CD193	SN1610-5	17.9	x	10.8	x	5	15.9	x	10.1	10	CD207	CD216	CD225
CD180	CD194	SN1812-6	19.8	x	12.8	x	6	18.1	x	11.9	10	CD208	CD217	CD226
CD181	CD195	SN1812-8	20.6	x	13.0	x	8	18.0	x	12.3	10	CF673	CF672	CD227
CD182	CD196	SN2010-7	24.1	x	11.4	x	6.9	20.0	x	10.7	10	CD210	CD219	CD228
CD183	CD197	SN2010-9	24.1	x	11.4	x	9	20.0	x	10.6	10	CD210	CD219	CD228
CD184	CD198	SN2214-5	24.3	x	14.8	x	5.1	21.7	x	14.0	8	CD211	CD220	CD229
CD185	CD199	SN2214-8	24.3	x	14.8	x	8	21.5	x	13.9	8	CD211	CD220	CD229
CD186	CD200	SN2217-6	25.3	x	18.1	x	6.1	21.4	x	18.1	10	CD212	CD221	CD230
CD187	CD201	SN2217-10	25.3	x	18.1	x	10.1	22.8	x	17.3	5	CD212	CD221	CD230
CD188	CD202	SN2419-4	27.5	x	19.9	x	14.1	23.1	x	18.9	5	CD213	CD222	CD231
CD189	CD203	SN2713-7	29.6	x	13.8	x	7	26.7	x	12.9	10	N/A	N/A	N/A
CD190	CD204	SN2716-11	30.6	x	16.9	x	11.1	26.3	x	15.9	5	CD214	CD223	CD232
CD191	CD205	SN3023-8	34.1	x	24.0	x	8.1	30.1	x	21.6	5	N/A	N/A	N/A
CD192	CD206	SN3919-14	42.5	x	20.1	x	14.1	38.1	x	19.0	5	CD215	CD224	CD233

STACK & NEST TOTES

- Will stack with or without lids for maximum storage and shipping
- Ability to stack and can be turned 180° to nest when empty
- Textured bottoms ensure safe and easy, non-slip grip transit on conveyors
- Injection-molded from high-density polyethylene material
- Will not rust, corrode or bend out of shape
- Are unaffected by chemicals and are waterproof
- Fit on standard 48" x 40" pallets
- Can withstand temperature ranges from -10°F to 250°F
- Ribs under lip prevent jamming when nested
- Handle grips on either side
- Made of FDA compliant materials



Optional lids protect container contents. As pictured, lids can be fastened and locked for added security



All nine sizes of totes have the ability to use the optional clear label holder. It securely attaches to SNT with or without lid for easy part identification.

CONTAINERS

Blue	Model No.		Mfg. No.	Outside Dimensions				Inside Dimensions				Qty /Case	Blue	Model No.		Qty /Case		
	Grey	Red		L"	x	W"	x	H"	L"	x	W"			x	H"		Grey	Red
CC315	CC316	CC317	SNT180	18	x	11	x	6	15 1/4	x	9 3/8	x	5 7/8	6	CC342	CC343	CC344	6
CC318	CC319	CC320	SNT185	18	x	11	x	9	15 1/8	x	9 1/8	x	8 7/8	6	CC342	CC343	CC344	6
CC321	CC322	CC323	SNT190	19 1/2	x	15 1/2	x	10	16	x	13 1/4	x	9 7/8	6	CC345	CC346	CC347	6
CC324	CC325	CC326	SNT195	19 1/2	x	15 1/2	x	13	15 7/8	x	13 3/8	x	12 7/8	6	CC345	CC346	CC347	6
CC327	CC328	CC329	SNT200	19 1/2	x	13 1/2	x	8	16 3/8	x	11 1/2	x	7 7/8	6	CC348	CC349	CC350	6
CC330	CC331	CC332	SNT225	23 1/2	x	19 1/2	x	10	19 3/8	x	16 7/8	x	9 7/8	3	CC351	CC352	CC353	3
CC333	CC334	CC335	SNT230	23 1/2	x	19 1/2	x	13	19 1/2	x	16 7/8	x	12 7/8	3	CC351	CC352	CC353	3
CC336	CC337	CC338	SNT240	23 1/2	x	15 1/2	x	12	19 5/8	x	13	x	11 7/8	3	CC354	CC355	CC356	3
CC339	CC340	CC341	SNT300	29 1/2	x	19 1/2	x	15	25 1/8	x	16 5/8	x	14 7/8	3	CC357	CC358	CC359	3

LIDS

Model No. CC360

Label holder, accommodates up to 3" x 5". Fits all SNT containers.

QUANTUB NESTING TOTES

- High-density polyethylene
- Rolled top rim for comfortable grip
- Eight 1/4" position drill holes on bottom allow for drainage
- Dimensions: 24 1/2" L x 19" W x 9 1/2" H
- Made of FDA approved materials

Model No. CD244 Grey

Model No. CD434 Blue

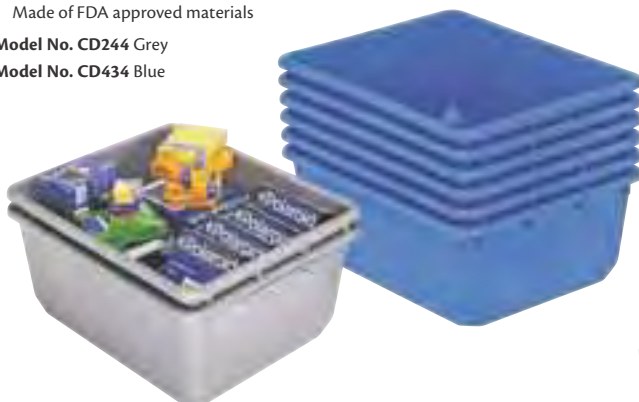

COLLAPSIBLE CONTAINERS

- Polypropylene construction
- Collapses to 21" L x 14" W x 2" H for convenient storage
- Open dimensions: 21" L x 14" W x 10 1/2" H
- Reinforced base for added durability
- 16 heavy-duty steel pins built in for increased strength
- Capacity: 160 lbs.

Model No. CF326



STAKPAK & DIVIDER BOX CONTAINERS

STAKPAK PLUS 4845 SYSTEM CONTAINERS

- Stack-only, injection molded, straight-wall modular containers
- High-density polyethylene (HDPE)
- Reinforced external ribbing adds maximum stacking strength
- Smooth, straight interior walls provide maximum space utilisation and easy cleaning
- Modular design optimizes cube on standard 45" x 48" pallet, allows for mixing and matching of various sizes
- Ergonomically designed handles for comfort and safety
- Containers hold up under temperatures from -10°F to 120°F
- Optional cardholders available

ORBIS



48" x 15" (1/3)
24" x 15" (1/6)
12" x 15" (1/12)
12" x 7" (1/24)



48" x 22" (1/2)
24" x 22" (1/4)
24" x 11" (1/8)



16" x 15" (1/4)
on AIAG 30" x 32"
15" x 15" (1/9)
on AIAG 45" x 48"



12" x 15" (1/6)

Model No.		Pallet Modularity		Outside Dimensions		Total Container Height"	Product Clearance"	Volume cu.ft.	48' Trailer Capacity (containers)	Wt. lbs.	Lids Model No.			Cardholder Model No.	
Medium Green	Royal Grey	Royal Blue	30" x 36"	AIAG 45" x 48"	Top L" x W"						Bottom L" x W"	Medium Green	Royal Grey		Royal Blue
STAKPAK CONTAINERS															
CA498	CA499	CC112	1/12	1/24	12.0 x 7.4	12.0 x 7.4	5.0	4.5	0.1	8640	1.1	N/A	CA488	N/A	CA448
CA500	CA501	CC113	1/6	1/12	12.0 x 15.0	12.0 x 15.0	5.0	4.4	0.3	4320	1.6	CA489	CA490	CC121	CA448
CA502	CA503	CC114	1/6	1/12	12.0 x 15.0	12.0 x 15.0	7.5	6.8	0.5	3456	2.2	CA489	CA490	CC121	CA449
CA504	CC174	CC115	1/6	1/12	12.0 x 15.0	12.0 x 15.0	9.5	8.8	0.6	2304	2.5	CA489	CA490	CC121	CA449
CA507	CA508	CC116	-	1/6	24.0 x 15.0	24.0 x 15.0	5.0	4.5	0.7	2592	3.0	CA491	CA492	CC122	CA448
CA509	CA510	CC117	-	1/6	24.0 x 15.0	24.0 x 15.0	7.5	6.8	1.1	1728	3.6	CA491	CA492	CC122	CA449
CA511	CA512	CC118	-	1/6	24.0 x 15.0	24.0 x 15.0	9.5	8.8	1.4	1296	4.4	CA491	CA492	CC122	CA449
CA505	CA506	CC119	-	1/6	24.0 x 15.0	24.0 x 15.0	14.5	13.8	2.2	864	5.7	CA491	CA492	CC122	CA449
STAKPAK LIDS															
-	CA488	-	-	-	12.0 x 7.4						0.4	CARDHOLDERS			
CA489	CA490	CC121	-	-	12.0 x 15.0						0.6	Model No.	Dimensions L" x W"		
CA491	CA492	CC122	-	-	24.0 x 15.0						2.1	CA448	8.5 x 4.0		
												CA449	8.5 x 4.6		

* When containers are stacked on top of each other approximately 1/2" is lost to nesting.

DIVIDER BOX® CONTAINERS

- Divider Box® (DC) series containers are injection-molded HDPE
- DG series are injection-molded from high-density FDA approved polyethylene which resists most solvents and chemicals
- Large, flat areas on all four sides for content identification
- Comfort grip handle
- Stacking rims and multi-ribbed external sides provide high impact strength
- All containers can be divided into compartments by length and/or width
- Molded-in stacking ridge assures containers will stack securely with or without covers
- One set of cardholder snaps and security tie holes on two ends included on DC models only
- Full range of optional accessories available including velcro card holders for DG models and snap-on card holders for DC models, vertical dividers and covers
- Optional dolly (CF400) allows for easy transport



CARD HOLDERS

Model No.			Mfg. No.	Dimensions			Volume cu.ft.	Wt. lbs.	Short Dividers		Long Dividers		Clear Lids Model No.	Snap-on or Velcro Model No.
Grey	Red	Blue		Outside L" x W" x H"	Inside L" x W" x H"	Model No.			No. of Slots	Model No.	No. of Slots			
CA562	CC833	CC846	DC1025	10.8 x 8.3 x 2.5	9.2 x 6.6 x 2.5	0.07	0.5	CA568	7	CA571	5	CA556**	CC314	
CC641	CC934	CC946	DG91035	10.9 x 8.3 x 3.5	9.2 x 6.6 x 3.0	0.10	0.9	CC659	7	CC650	5	CD437*	CF351	
CC642	CC935	CC947	DG91050	10.9 x 8.3 x 5.0	9.2 x 6.6 x 4.5	0.19	1.2	CC660	7	CC651	5	CD437*	CF352	
CA565	CC836	CC849	DC2025	16.5 x 10.9 x 2.5	14.8 x 9.2 x 2.5	0.16	0.9	CA571	11	CA577	7	CA559/CA561**	CC314	
CC643	CC936	CC948	DG92035	16.5 x 10.9 x 3.5	14.9 x 9.3 x 3.0	0.24	1.42	CC661	11	CC652	7	CD438*	CF351	
CC644	CC937	CC949	DG92060	16.5 x 10.9 x 6.0	14.9 x 9.3 x 5.5	0.44	1.88	CC662	11	CC653	7	CD438*	CF352	
CA566	CC840	CC853	DC2070	16.5 x 10.9 x 7.0	15.0 x 9.3 x 7.0	0.51	1.7	CA575	11	CA581	7	CA559/CA561**	CA446/CC314	
CC645	CC938	CC950	DG92080	16.5 x 10.9 x 8.0	14.9 x 9.3 x 7.5	0.60	2.5	CC663	11	CC654	7	CD438*	CF353	
CC646	CC939	CC951	DG93030	22.5 x 17.5 x 3.0	20.6 x 15.6 x 2.5	0.44	2.5	CC664	15	CC655	11	CD439*	CF351	
CA567	CC842	CC855	DC3050	22.4 x 17.4 x 5.0	20.3 x 15.3 x 5.0	0.79	2.6	CA584	15	CA588	11	CA560/CD456**	CA446/CC314	
CC647	CC940	CC952	DG93060	22.5 x 17.5 x 6.0	20.6 x 15.6 x 5.5	0.97	4	CC665	15	CC656	11	CD439*	CF352	
CC648	CC941	CC953	DG93080	22.5 x 17.5 x 8.0	20.6 x 15.6 x 7.5	1.32	4.67	CC666	15	CC657	11	CD439*	CF353	
CC649	CC942	CC954	DG93120	22.5 x 17.5 x 12.0	20.6 x 15.6 x 11.5	2.03	5.67	CC667	15	CC658	11	CD439*	CF353	

* Grey, red and blue covers available. ** Grey and blue covers available.

DISTRIBUTION CONTAINERS

These reusable, returnable, attached-lid containers are ideal for use in wholesale product distribution and as picking containers. Hinged covers with tight interlocking fit provide maximum security and protection. Containers stack with lids closed and nest with lids open for optimum use of space in trucks, trailers or on pallets. Pebble grain bottom surface provides extra traction on conveyors. Load capacity per container is a maximum of 70-75 lbs. Bottom container will support 250 to 300 lbs. when stacked. (Please inquire for exact load capacities). Flipak™ containers are available in polyethylene plastic (PE) and polypropylene plastic (PP).

FLIPAK® POLYETHYLENE PLASTIC (PE) DISTRIBUTION CONTAINERS

- High-density polyethylene (HDPE) construction offers maximum product protection from moisture, impact and chemicals



ORBIS

Grey	Model No.		Outside Dimensions				Volume cu. ft.	Nesting Ratio	Wt. lbs.	
	Red	Blue	Top		Bottom					
			L"	W"	H"	L"	W"			
LESS THAN 2.0 CU.FT.										
CA452	-	CF265	11.8	9.8	7.7	9.3	7.0	0.3	2.8:1	2.1
CA453	-	CF266	15.2	10.9	9.7	12.8	7.8	0.6	4.0:1	3.0
CA454	-	-	21.8	15.1	5.5	18.9	13.7	0.7	3.6:1	4.8
CA455	-	CF268	19.7	11.8	7.3	16.9	9.3	0.7	3.0:1	3.4
CA456	-	-	20.6	13.5	6.5	18.2	11.7	0.8	2.1:1	5.2
CA457	-	-	20.6	13.2	11.6	17.7	11.0	1.4	4.4:1	5.9
CF559	CF556	CF557	21.9	15.2	9.3	19.1	13.3	1.3	4.4:1	5.0
CA461	-	CF273	22.3	13.0	12.8	19.1	10.9	1.6	3.8:1	6.2
CA462	CA463	CF274	21.8	15.2	12.9	18.6	12.9	1.8	4.0:1	6.5
CA464	-	-	23.5	15.7	13.0	19.9	13.0	1.9	4.5:1	6.9
2.0 CU.FT. & GREATER										
CF504	CF503	CF506	26.9	16.9	12.1	24.4	14.7	2.4	4.2:1	8.2
CA468	CA469	CF277	23.9	19.6	12.6	21.1	17.1	2.7	5.3:1	8.4
CA471	-	-	39.0	14.0	13.0	36.3	11.3	3.3	4.9:1	10.4
CA475	-	-	30.0	22.0	20.5	27.4	19.4	6.1	4.0:1	17.0

FLIPAK® CLEAR POLYPROPYLENE PLASTIC (PP) DISTRIBUTION CONTAINERS

- Offer all the same benefits as the polyethylene containers, plus provide easy content identification
- Polypropylene (PP) is the same family as polyethylene
- Polypropylene's advantages over polyethylene include its greater stiffness and elevated use
- Temperature range: 30°F - 150°F



ORBIS

Model No.	Outside Dimensions				Volume cu. ft.	Nesting Ratio	Wt. lbs.	
	Top		Bottom					
	L"	W"	H"	L"	W"			
LESS THAN 2.0 CU.FT.								
CC128	11.8	9.8	7.7	9.3	7.0	0.3	2.8:1	2.1
CC129	15.2	10.9	9.7	12.8	7.8	0.6	4.0:1	3.0
CC130	19.7	11.8	7.3	16.9	9.3	0.7	3.0:1	3.4
CF558	21.9	15.2	9.8	19.1	13.3	1.4	4.4:1	5.0
CC132	21.8	15.2	12.9	18.6	12.9	1.8	4.0:1	6.2
2.0 CU.FT. & GREATER								
CF505	26.9	16.9	12.1	24.4	14.7	2.3	5.3:1	7.8

FLIP TOP ECONOMY CONTAINERS

- Stacks when lid is closed
- Nests when empty
- Recessed carry handles
- Dimensions:
21 1/2" L x 15" W x 12 1/2" H
- Capacity: 45 litres
- Weight: 5 lbs.

TRANSLUCENT

Model No. CD383 Black Top
Model No. CF555 Red Top

GREY

Model No. CD459



iP
INTEGRATED PLASTICS

FDA APPROVED POLY CONTAINERS

BUS/UTILITY BOXES

- Made of durable, commercial grade plastic
- Reinforced handles, bottom and ribs for added strength
- Dimensions: 20" L x 15" W x 5" H
- Capacity: 17.5 L
- Certified to NSF Std. #2 (splash zone)
- USDA Meat & Poultry Equipment Group Listed and assists in complying w/HACCP guidelines



Model No. CD445 Grey
Mfg. No. 3349
Model No. CD446 White
Mfg. No. 3349
Model No. CD662 Grey Cover
Mfg. No. 3648



GENERAL PURPOSE PAILS

- Snap on lids available:
Dry seal type or **gasket type** for liquid handling
- Galvanised steel handles except **CB040**



ROPAK

Model No.	Description	Dimensions Dia" x W"	Lid Type	Wt. lbs.
CB040	4-L Pail w/Plastic Handle	8 1/4 x 6	-	0.5
CB039	Lid for Pails 4, 5, 6 L w/Static Joint	8 1/2 x 1/2	Gasket	0.2
CB043	11.4-L Pail w/Metal Handle	11 x 9	-	1.1
CB041	Lid for Pails 11.4 L w/o Static Joint	11 3/8 x 5/8	Dry Seal	0.3
CB046	20-L Pail w/Metal Handle	11 7/8 x 15 3/8	-	2.0
CC426	Lid for 20-L pail	12 1/2 x 5/8	Dry Seal	0.4
CB045	Heavy-duty Lid for 20 and 23-L Pails w/Pouring Spout	12 1/8 x 3/4	Gasket	0.6

CROSS STACK BINS

- Ideal for production, assembly and order picking
- Injection-molded from high-impact polyethylene; will not crack or rust, and easy to clean
- Can be turned 90° to cross stack
- Built-in handle and bottom grooves for easy handling
- Capacity: 100 lbs.
- Made of FDA compliant materials
- Optional clear label holder **CC360**
- Drill hole pattern on bottom can be opened for drainage purposes



CONTAINERS

LIDS

Model No.			Dimensions			Model No.		
Blue	Grey	White	L" x W" x H	Blue	Grey	White		
CD583	CD584	CD585	17 1/4 x 11 x 12	CF016	CD586	CF017		
CD247	CD246	CD248	25 1/8 x 16 x 8 1/2	CF018	CD606	CF019		

CYLINDRICAL TANKS

- Ideal for plating, compounding, pickling, and mixing
- Cylindrical tanks are self-supporting when filled
- Natural translucent walls permit visual inspection of contents at all times
- An assortment of fittings may be installed to meet the most demanding applications
- Colour: Natural white
- Other sizes available up to 500-lb. capacity
- Accepted for use in Canadian food processing facilities



TANKS

LIDS

Model No.	Capacity Imp. Gal.	Inside Dia. "	Tank Depth "	Wt. lbs.	Model No.	Wt. lbs.
CA074	5	11	16	3	CA075	1
CA027	12	13	27	4	CA028	1
CA020	15	16	24	6	CA026	1
CA025	25	16	35	8	CA026	1
CA021	30	18	33	10	CA022	1
CA067	30	20	27 1/2	11	CA068	2
CA036	45	22 1/2	34	18	CA037	3
CA076	60	22 1/2	45	22	CA077	3
CA078†	75	24	48	23	CA079	3
CA034†	100	30	42	35	N/A	-
CA038†	150	36	42	45	CA039	8
CA054†	175	36	48	55	CA055	8

† F.O.B. Milton, Ontario

RECTANGULAR TANKS

- Ideal for storage and mixing at constant temperatures up to 150°F or 170°F intermittent
- Lids available for most sizes
- To prevent bulging under continuous heavy and liquid load, simple bracing of steel, plywood or lumber is recommended
- Straight sides, external lip unless otherwise stated
- Colour: Natural white
- Other sizes available up to 300 lbs.
- Accepted for use in Canadian food processing facilities



TANKS

LIDS

Model No.	Capacity Imp. Gal.	Inside Dim.			Wt. lbs.	Model No.	Wt. lbs.		
		L"	x	W"	x	D"			
CA110	6	11	x	11	x	15	6	N/A	-
CA065	15	24	x	15	x	11	10	N/A	-
CA069	15	45	x	22	x	5	18	N/A	-
CA084*	20	23	x	19	x	16	11	CA085	3
CA066	20	23	x	23	x	12	11	N/A	-
CA050	20	24	x	10	x	24	12	N/A	-
CA063	30	35	x	23	x	10	18	CA064	6
CA045**	30	30	x	14	x	24	16	N/A	-
CA071*	50	45	x	22	x	15	28	CA072	7
CA086	60	35	x	23	x	23	28	N/A	-
CA042†	75	42	x	24	x	24	32	CA043	7
CA089†	100	37	x	26	x	31	40	CA091	7
CA051†	140	54	x	30	x	24	70	CA052	11
CA030†	160	48	x	30	x	30	75	CA031	11
CA099†	190	60	x	30	x	30	75	N/A	-
CA056†	300	72	x	36	x	33	135	CA057	15

* Tapered sides ** Top dimensions restricted. † F.O.B. Milton, Ontario

HEAVY-DUTY TILT BINS

- Extremely durable ABS plastic housing and drawer body
- Transparent polystyrene front window for easy viewing
- Conveniently connects to each other with grooved channels on top, bottom and sides
- Shake resistant design prevents drawers from opening on their own
- Keyholes on back for wall mounting applications
- Colour: Black and grey



Model No.	No. of Drawers	Bin Dimensions				Cabinet Dimensions				Wt. lbs.		
		W"	x	D"	x	H"	W"	x	D"		x	H"
CF471	8	23/4	x	3 1/4	x	3 5/8	11 3/4	x	23/4	x	7 7/8	1.8
CF472	6	3 11/16	x	4	x	4 5/8	11 3/4	x	3 1/2	x	9 3/4	2.26
CF473	5	4 1/2	x	4 7/8	x	5 1/2	23 1/2	x	4	x	5 7/8	2.84
CF474	4	5 5/8	x	6 3/8	x	7 1/2	23 1/2	x	5 1/2	x	7 7/8	3.10

MOBILE TILT BIN RACKS

- Heavy-duty steel frame
- Durable powder coat paint finish on galvanized steel
- 3" swivel casters with brake
- Single or double-sided use
- Overall dimensions: 26 1/4" W 22" D x 57 1/2" H
- Colour: Grey



MOUNTING CHANNELS FOR MOBILE TILT BIN RACK

- Single side of mixed size tilt bins, any combination, takes up to six mounting channels per side
- Single side CF473 tilt bins only takes up to eight mounting channels per side
- CF471 and CF472 takes two bin units per level per side

Model No.	Description	Bin Units Included
CF477	Single-Sided	2 of each CF471, CF472, CF473, CF474
CF478	Double-Sided	4 of each CF471, CF472, CF473, CF474
CF475*	Cart Only	-
CF476	Mounting Channel for Tilt Bins	-
CF502	Mounting Channel for Hanging Bins**	-

* Mounting channels and bins not included

** See page 3 for hanging bins

ROTABIN STORAGE UNITS

- Revolving units allow for greater accessibility and visibility
- Shelves sit securely on ball bearings
- Held with a solid steel pin
- Each shelf rotates smoothly and independently

28" DIAMETER

- Six permanent 14 1/2" wide compartments per shelf
- Extra CA221 dividers can be inserted on 1" centres
- Capacity: 500 lbs. per shelf

34" DIAMETER

- Five permanent 21" wide compartments per shelf
- Extra CD463 dividers can be inserted on 1" centres
- Optional removable pans for 34" diameter units allow for easy parts inventory, restocking, transporting to work area or to get weighted
- Capacity: 500 lbs. per shelf



Model No.	No. of Shelves	No. of Pans*	Unit Height"	Wt. lbs.
UNIT ONLY 28" (PANS NOT AVAILABLE)				
CA193	5	-	38	125
CA194	6	-	41	144
CA195	7	-	47	163
CA196	8	-	53	182
CA197	9	-	60	201
CA198	10	-	66	220
UNIT ONLY 34" (PANS NOT INCLUDED)				
CA225	4	60	35	135
CA226	5	75	43	162
CA227	6	90	50	188
CA228	7	105	66	215
CA229	8	120	66	240
GREY PANS FOR 34" UNIT				
CA258	-	-	-	-

* Max number of pans (pans not included)



CA229 shown with CA258 pans

STORAGE SYSTEMS

TIP-OUT™ BIN MODULAR STORAGE SYSTEMS



- Each bin has a slot for labeling
- Bins can be completely removed for replenishing or cleaning
- Uniform widths of 23.6" (for units of two to nine bins)
- Can be used free-standing or with stands and pedestals

- Transparent compartments tip out for easy access and viewing
- Two of **CB573** disc and screw set are needed for every bin
- Colour: Beige or grey

TILT BINS

Model No.	Mfg. No.		No. of Bins	Bin Dimensions				Cabinet Dimensions				Wt. lbs.		
	Beige	Grey		W"	x	D"	x	H"	W"	x	D"		x	H"
CB552	CB553	QTB309	9	23/16	x	13/4	x	2 1/2	23 5/8	x	2 1/2	x	3 1/8	2.0
CB549	CB550	QTB306	6	3 1/2	x	2 5/8	x	3 3/4	23 5/8	x	3 5/8	x	4 1/2	3.0
CB546	CB547	QTB305	5	4 1/4	x	3 3/4	x	5 3/4	23 5/8	x	5 1/4	x	6 1/2	5.0
CB543	CB544	QTB304	4	5 5/8	x	5	x	7 1/2	23 5/8	x	6 5/8	x	8 1/8	7.0
CB540	CB541	QTB303	3	7 3/8	x	5 7/8	x	8 5/8	23 5/8	x	7 3/4	x	9 1/2	9.0
CB977	CB978	QTB302	2	11 1/16	x	8 7/8	x	13 5/8	23 5/8	x	11 7/8	x	13 7/8	14
CB975	CB976	QTB301	1	11 1/16	x	8 7/8	x	13 5/8	11 3/16	x	11 7/8	x	13 7/8	7
CB573	Two Discs and Two Screw Set (Two Needed for Each Bin Case)													

TIP OUT™ FRAMES

- Assembly required



FRAME ONLY: BINS NOT INCLUDED

Model No.	Description	Dimensions				Bin Quantity Table QTB Series Bins						
		W"	x	D"	x	H"	302	303	304	305	306	309
FLOOR STANDS												
CB562	48" 1-Sided	23 5/8	x	8	x	52	3	5	6	7	11	16
CB563	70" 1-Sided	23 5/8	x	8	x	75	5	7	8	10	15	23
CB565	48" 2-Sided	23 5/8	x	16	x	52	6	10	12	14	22	32
CB568	70" 2-Sided	23 5/8	x	16	x	75	10	14	16	20	30	46
MOBILE FLOOR STANDS												
CB952	48" 2-Sided	23 5/8	x	16	x	52	6	10	12	14	22	32
CB953	70" 2-Sided	23 5/8	x	16	x	75	10	14	16	20	30	46
WALL FRAMES												
CB559	48"						3	5	6	7	11	16
CB561	70"						5	7	8	10	15	23
CB573	Two Discs & Two Screws Set											

HEAVY-DUTY PARTS CABINETS

- New design allows 98% use of drawer space to store larger tools or materials
- Housed in an all-welded 22-gauge galvanized steel cabinet
- I.D. card with clear plastic shield and divider included with every drawer
- Steel tabs and drawer stoppers allow for full extension without risk of spilling
- Cabinet has either polystyrene or heavy-duty ABS beige drawers
- Grey enamel finish





CA891



CF283



CA889



CD440



CC453



CA890



CF289



CF293

Model No.	No. of Drawers	Drawer Description	Drawer Dimensions			Cabinet Dimensions			Wt. lbs.
			W"	x	D" x H"	W"	x	D" x H"	
CF311	18	Polystyrene	3.5	x	8.6 x 2.2	13.9	x	8.7 x 16.3	19
CF312	20	Polystyrene	3.5	x	8.6 x 2.2	18.3	x	8.7 x 13.8	21
CF314	40	Polystyrene	3.5	x	8.6 x 2.2	18.3	x	8.7 x 25.3	40
CF313	25	Polystyrene	3.5	x	8.6 x 2.2	23.1	x	8.7 x 13.8	27
CF315	75	Polystyrene	3.5	x	8.6 x 2.2	23.1	x	8.7 x 36.9	66
CF305	16	Polystyrene	3.5	x	8.6 x 2.7	18.3	x	8.7 x 13.8	21
CF304	15	Polystyrene	3.5	x	8.6 x 2.7	13.9	x	8.7 x 16.3	22
CF306	20	Polystyrene	3.5	x	8.6 x 2.7	23.1	x	8.7 x 13.8	27
CC453	32	Polystyrene	3.5	x	8.6 x 2.7	18.1	x	8.7 x 25.6	31
CC454	60	Polystyrene	3.5	x	8.6 x 2.7	22.6	x	8.7 x 36.9	68
CF298	16	ABS	4.7	x	8.6 x 2.7	23.1	x	8.7 x 13.8	24
CA891	24	ABS	4.7	x	8.6 x 2.7	17.3	x	8.7 x 25.6	33
CA892	48	ABS	4.7	x	8.6 x 2.7	22.6	x	8.7 x 36.9	58
CD440*	48	ABS	4.7	x	8.6 x 2.7	22.6	x	10.8 x 36.9	66.8
CA889	30	ABS	5.9	x	9.8 x 3.3	21.3	x	10.4 x 36.9	58
CF289	24	Polystyrene	5.9	x	9.8 x 1.6	14.3	x	10.4 x 22.5	32
CA890	60	Polystyrene	5.9	x	9.8 x 1.6	21.3	x	10.4 x 36.9	60
CF293	18	Polystyrene	5.9	x	9.8 x 1.6	21.3	x	10.4 x 12.2	25
CF283	12	ABS	6.4	x	11.3 x 2.7	23	x	11.4 x 13.8	28
CF284	24	ABS	6.4	x	11.3 x 2.7	23	x	11.4 x 25.2	47
CF285	36	ABS	6.4	x	11.3 x 2.7	23	x	11.4 x 36.9	60

* Comes with locking doors

HEAVY-DUTY INDUSTRIAL CAROUSEL DRAWER CABINETS

- Create your customized carousel cabinet
- Each level accommodates four parts cabinets with same height
- For a multiple tier cabinet (maximum three tiers), you require add-on-shelves and threaded rods as per the following:
 - One add-on-shelf **CF402** for each level of cabinets
 - 14" rod required for each level of **CF312** or **CF305** cabinets
 - 25" rod required for each level of **CC453** or **CF314** cabinets
- Rotational base allows for 800-lb. capacity
- All-welded 11-gauge steel base
- Durable Kleton grey enamel finish

CF408 (Kit)



Model No.	Description	Dimensions			Wt. lbs.
		W"	x	D" x H"	
3 TIER CABINETS KITS					
CF405	192 Drawers	27	x	27 x 48	392
CF406	240 Drawers	27	x	27 x 48	407
CF407	384 Drawers	27	x	27 x 80	497
CF408	480 Drawers	27	x	27 x 80	600
COMPONENTS					
CF401	Base and Top Cover	27 1/2	x	27 1/2 x 4	80
CF402	Add-on Shelf	27 1/2	x	27 1/2 x 1	18
CF403	Threaded Rod - 14"	3/8	x	- x 14	1
CF404	Threaded Rod - 25"	3/8	x	- x 25	1.5
CF305	Parts Cabinet - 16 Drawers	18 5/16	x	8 11/16 x 14	21
CF312	Parts Cabinet - 20 Drawers	18 5/16	x	8 11/16 x 14	21
CC453	Parts Cabinet - 32 Drawers	18 5/16	x	8 11/16 x 25	31
CF314	Parts Cabinet - 40 Drawers	18 5/16	x	8 11/16 x 25	40

INCLUDES:

- 12 - CF314 - Cabinet - 40 drawers
- 1 - CF401 - Base and Top Cover
- 2 - CF404 - Threaded Rod 25"
- 2 - CF402 - Add-on Shelf

PARTS CABINETS

CAROUSEL DRAWER CABINETS

- Designed to utilize open and often unused areas such as corners
- Optional turntable can be used to create a rotary carousel unit providing convenience for accessing small parts storage
- All-welded cabinets include clear drawers, dividers and I.D. labels
- Cabinet overall dimension: 12" W x 5 3/4" D x 22" H
- Blue enamel finish
- Turntable **CA912** may be set up with up to three levels of four cabinets per level

Model No.	No. of Drawers	Drawer Model No.	Drawer Dimensions				Wt. lbs.
			W"	x	D"	x H"	
CA870	60	CD441	2	x	5 5/16	x 1 3/8	10.7
CA869	48	CD442	2 1/2	x	5 5/16	x 1 3/8	10.7
CA868	30	24 x CD442	2 1/2	x	5 5/16	x 1 3/8	10.7
		4 x CD443	5 5/16	x	5 5/16	x 2 1/4	-
		2 x CD444	11	x	5 5/16	x 2 1/4	-
CA867	16	CD443	5 5/16	x	5 5/16	x 2 1/4	10.3
CA912	-	3 Tier Turntable Unit Only				40.0	



CA867
16-Drawer Cabinet



CA868
30-Drawer Cabinet

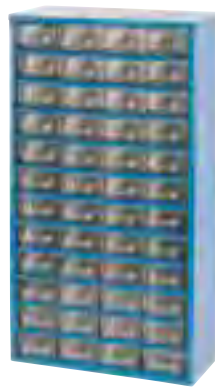

CA869
48-Drawer Cabinet



CA870
60-Drawer Cabinet

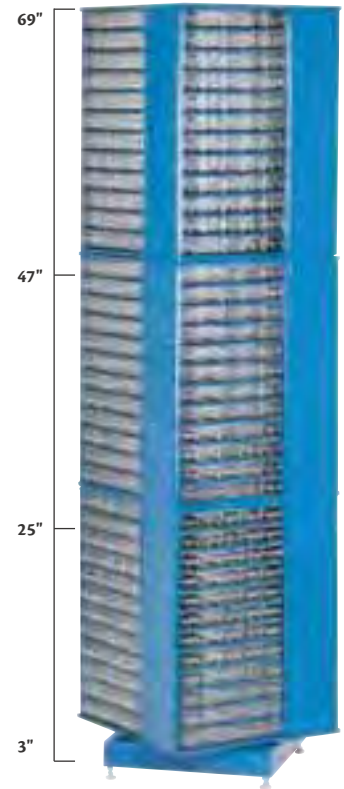

CA912 - Turntable Base
Turntable unit shown with 12 CA870 cabinets (sold separately)

ADD-A-DRAWER®

- Grey plastic drawer modules with clear windows simply slide and lock onto each other
- Can be stacked both horizontally and vertically
- Allows you to create a customized drawer cabinet
- Add on one or more units as more storage capacity is required
- Dividers and labels included



CA841 Shown with two units



CA844 Shown with two units



CA842 Shown with two units

Customize your drawer cabinet!



CA877



CA855



CD234

Model No.	No. of Drawers	Dimensions				Colour	Wt. lbs.
		W"	x	D"	x H"		
DRAWER MODULES							
CA840	2	5	x	5	x 2	Grey	0.88
CA841	1	2 1/2	x	5	x 2	Grey	0.20
CA842	1	4 1/2	x	10	x 2 1/2	Grey	1.00
CA844	1	5	x	5	x 2	Grey	0.20
CA843	4	3	x	6	x 5 3/4	Blue	1.0
CA845	2	6	x	6	x 3	Blue	1.0
CA846	1	6	x	6	x 3	Blue	1.0
CA847	1	12	x	6	x 3	Blue	1.6
CABINET KITS							
CD234	4	4 1/2	x	10 1/2	x 10	Grey	4
CD235	42	15	x	5	x 16	Grey	15.5
CA877	32	12	x	6	x 10 1/2	Blue	8.0
CA874	27	12	x	6	x 17 3/4	Blue	11.6
CA855	19	12	x	6	x 11 3/4	Blue	7.6

WORKBENCH SMALL PARTS CABINETS

- Ideal for storing small parts right on your workbench
- New design allows for 98% use of drawer space
- I.D. cards and dividers included with every drawer
- Heavy-duty ABS beige drawers
- 30 drawers, dimensions: 6.5" W x 14.8" D x 4.1" H
- Cabinet: 34.6" W x 15.7" D x 34.6" H
- Housed in an all-welded galvanized steel container finished in a grey enamel paint
- Weight: 119 lbs.

Model No. CF323

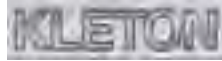

CF318

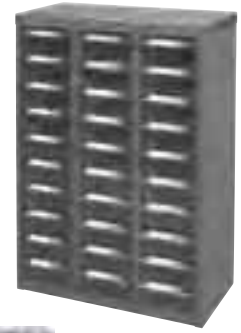

CF319

KPC-700 PARTS CABINETS

- Drawer size: 4.7" W x 8.6" D x 2.2" H
- Clear polystyrene drawers

Model No.	No. of Drawers	Dimensions			Wt. lbs.
		W"	D"	H"	
CF318	20	23.1	8.7	13.6	25
CF319	30	17.5	8.7	25.3	40
CF320	60	23.1	8.7	36.9	71

HEAVY-DUTY DRAWER CABINETS

- Heavy-duty parts cabinets feature break resistant high impact clear plastic "scoop" drawers for easy removal of small parts, with two adjustable compartment dividers
- Drawers dimensions: 2 7/8" W x 5 1/2" D x 1 7/8" H
- Welded steel cabinets are finished in grey powder coat

DURHAM MFG
Est. 1922

Model No.	No. of Drawers	Cabinet Dimensions			Wt. lbs.
		W"	D"	H"	
CA899	64	25 1/2	6 1/2	21 3/4	34
CA898	20	16 1/2	6 1/2	11 1/4	12



CA899



CA898

MODULAR PARTS CABINETS

- Organize and control small parts inventory
- Standard cabinets come with light grey polystyrene drawers that are virtually indestructible
- Transparent windows on drawer fronts
- Label holder on drawer pull allows for instant identification
- Comes with two removable dividers per drawer
- Stackable steel cabinet frames finished in grey baked enamel
- Cabinet frame dimensions: 17" W x 11" D x 11" H
- **Includes:** Two dividers and one label per drawer

CA853



CA854



CA857



CA858



CA856

Model No.	No. of Drawers	Drawer Dimensions			Wt. lbs.	Dividers Model No.	Replacement Drawers Model No.
		W"	D"	H"			
CA853	28	2 3/16	10 9/16	2 1/16	CB126	CA859	
CA854	20	3 3/16	10 9/16	2 1/16	CB133	CC143	
CA856	16	4	10 9/16	2 1/8	CA878	CA860	
CA857	15	3 3/16	10 9/16	3 1/16	CA880	CA863	
CA858	9	5 3/16	10 9/16	3 1/16	CA882	CA865	

AKRO-MILS
CANADA

STEEL DRAWER CABINETS & CARTS



96 Drawers

72 Drawers

48 Drawers



B. 18-Drawer Cabinets



D. 9-Drawer Cabinets



C. 24-Drawer Cabinets



E. 30-Drawer Cabinets

A. 48, 72 & 96-Drawer Cabinets, Base included

INDUSTRIAL DRAWER CABINETS

- Provide a rugged modular storage system for small parts
- Select from a range of drawer capacities from 9 drawers to 96 drawers per cabinet
- Various drawer sizes are available including drawer heights of 2 3/4" and 3 1/2", and drawer depths of 11 1/8" and 17"
- Each drawer includes two adjustable dividers and full width handles
- Drawer sides are slotted to hold dividers

Type	Model No.	No. of Drawers	Drawer Dimensions					Cabinet Height"	Wt. lbs.	Replacement Drawers
			W"	x	D"	x	H"			
A	FI356	30	5 3/8	x	11 1/8	x	3 1/2	26 7/8	107	CD661
A	CA936	48	5 3/8	x	11 1/8	x	2 3/4	33 3/4	176	CA921
A	FI357	60	5 3/8	x	11 1/8	x	3 1/2	48	194	CD661
A	CA939	72	5 3/8	x	11 1/8	x	2 3/4	48 1/8	238	CA921
A	FI358	90	5 3/8	x	11 1/8	x	3 1/2	69 1/8	281	CD661
A	CA941	96	5 3/8	x	11 1/8	x	2 3/4	62 1/2	300	CA921
B	CA924	18	5 3/8	x	11 1/8	x	2 3/4	10 7/8	50	CA921
B	CA925	18	5 3/8	x	11 1/8	x	3 1/2	12 7/8	87	CD661
B	CA926	18	5 3/8	x	17	x	3 1/2	12 7/8	75	CA923
C	CA930	24	5 3/8	x	11 1/8	x	2 3/4	14 3/8	60	CA921
C	CA932	24	5 3/8	x	17	x	3 1/2	17	96	CA923
D	CA942	9	5 3/8	x	11 1/8	x	2 3/4	10 7/8	28	CA921
E	CA934	30	5 3/8	x	11 1/8	x	3 1/2	21 1/8	87	CD661
E	CA935	30	5 3/8	x	17	x	3 1/2	21 1/8	118	CA923
-	CA946		Extra Divider for 2 3/4" H Drawer					-	0.1	-
-	CA947		Extra Divider for 3 1/2" H Drawer					-	0.1	-

DURHAM MFG
Est. 1922

HEAVY-DUTY 2-SIDED MOBILE CART/WORK STATIONS

- Two rigid and two swivel casters with locking brakes
- Sturdy tubular handle allows ease of mobility
- Rubber tray mat provides safe, secure, non-skid work surface
- Finished in rust and acid resistant grey powder coat
- Heavy-duty casters, capacity of 1000 lbs.
- Shipped fully welded

DURHAM MFG
Est. 1922



Front



- Two 12-compartment bins back-to-back
- Overall dimensions: 34" W x 24" D x 32" H
- Ship weight: 139 lbs.

Model No. CD330



- Two 40-compartment bins back-to-back
- Overall dimensions: 34" W x 24" D x 32" H
- Ship weight: 159 lbs.

Model No. CD349

- One lockable 4-compartment storage cabinet
- One storage bin with 12 compartments
- 12 easily dividable pull out storage drawers, six on each side
- Overall dimensions: 34" W x 24" D x 36" H
- Ship weight: 180 lbs.

Model No. CD348



Back

STEEL STORAGE BINS

- Pigeonhole type steel storage bin units organize small parts
- Best suited where space is limited and organization is crucial
- Produced of prime cold rolled steel
- Fully welded, will not warp, twist or sag
- Fully hemmed label holders provide adequate space for content identification
- Each divider is hemmed in a tear drop design to avoid sharp edges
- Doors with padlock attachment and bases to raise units are available with most models
- All units are 33 3/4" wide and are available in depths of 12" or 8 1/2"
- 12" deep units feature a 45° slope front for easy removal of parts
- Finished in grey powder coat

DURHAM MFG[®]
Est. 1922

Perfect for organizing your shop - can be filled with just about anything!



CA151



CA152



CA154



CA136



CA133

Doors for storage bins



CA151 with CA141 and CA157

Base for storage bins



CA157



CA149

Model No.	Dimensions					No. of Bins	Bin Dimensions					Wt. lbs.	Base Model No.	Door Model No.
	W"	x	D"	x	H"		W"	x	D"	x	H"			
12" DEEP STORAGE BINS														
CA133	33 3/4	x	12	x	11 1/2	16	4	x	11 7/8	x	5 1/8	25	CA157	-
CA134	33 3/4	x	12	x	19 1/4	18	5 3/8	x	11 7/8	x	6 3/8	38	CA157	-
CA136	33 3/4	x	12	x	23 7/8	24	5 3/8	x	11 7/8	x	5 1/2	44	CA157	CA142
CA149	33 3/4	x	12	x	23 7/8	40	4	x	11 7/8	x	4 1/2	50	CA157	CA142
CA151	33 3/4	x	12	x	42	42	5 3/8	x	11 7/8	x	5 1/2	71	CA157	CA141
CA152	33 3/4	x	12	x	42	56	4 7/8	x	11 7/8	x	5 1/8	75	CA157	CA141
CA154	33 3/4	x	12	x	42	72	4	x	11 7/8	x	4 1/2	80	CA157	CA141
8 1/2" DEEP STORAGE BINS														
CA150	33 3/4	x	8 1/2	x	22 1/4	40	4	x	8 3/8	x	4 1/2	50	CA158	CA148
CA155	33 3/4	x	8 1/2	x	42	72	4	x	8 3/8	x	4 1/2	70	CA158	CA141

PLASTIC COMPARTMENT CASES

COMPACT POLYPROPYLENE COMPARTMENT BOXES

- High strength, oil resistant polypropylene, boxes with covers fitted with heavy-duty reinforced hinges
- Hinges have a special "stop" feature which allows the cover to remain in open position
- Covers overlap on all sides of the bottom tray
- Two snap latches assure secure closure
- Stackable



DURHAM MFG
Est. 1922

COMPARTMENT BOX CABINETS

- All steel grey powder coated cabinet holds five plastic compartment boxes
- Bolt holes permit stacking and keyhole slots are furnished for wall mounting



Model No.	Overall Dimensions				No. of Compartments	Compartment Dimensions					Wt. lbs.
	W"	x	D"	x H"		W"	x	D"	x	H"	
CB513	11	x	6 3/4	x 13/4	6	1 3/4	x	6 1/4	x	1 9/16	0.7
CB509	11	x	6 3/4	x 13/4	12	1 3/4	x	3 1/8	x	1 9/16	0.7
CB511	11	x	6 3/4	x 13/4	18	1 3/4	x	2 1/16	x	1 9/16	0.7
CB507	13 1/8	x	9	x 2 5/16	6	2	x	8 1/2	x	2	0.8
CB501	13 1/8	x	9	x 2 5/16	12	2	x	4 3/32	x	2	0.8
CB503	13 1/8	x	9	x 2 5/16	18	2	x	(6) 4 3/4 (12) 2	x	2	0.8
CB505	13 1/8	x	9	x 2 5/16	24	2	x	2	x	2	0.8

COMPARTMENT BOX RACKS

Model No.	Description	Dimensions				Wt. lbs.
		W"	x	D"	x H"	
CB631	Small Box Rack	11 1/4	x	6 3/4	x 10 3/4	7
CB632	Large Box Rack	13 1/2	x	9 1/8	x 13 1/4	11

COMPARTMENT CASE

- High strength, high quality polypropylene case
- Translucent lid allows for quick view of contents
- Snap latch ensures a secure closure
- Removable dividers allow for different configurations

TLZ117



CF333

aurora tools

Model No.	Overall Dimensions			No. of Compartments	Wt. lbs.
	W"	x D"	x H"		
CF333	10 3/4	x 5 3/8	x 1 1/2	Variable up to 17	0.7
TLZ117	5 3/8	x 5 3/8	x 1 3/8	Variable up to 9	0.3

LARGE CASES

18 1/2" L x 13" W

- Large Super Satchel organize tool cribs, maintenance departments, shop floors and allow complete portability
- See-through lids allow quick identification of contents
- Copolymer resins will not rust
- Brass pinned hinges provide strength and durability
- Identification card holder for quick case selection
- Molded integral feet, making ideal presentation cases

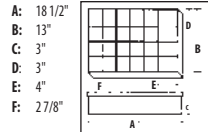

CB496
24 compartments
Wt.: 3.5 lbs.



- A: 18 1/2"
- B: 13"
- C: 3"
- D: 2 15/16"
- E: 2 1/8"

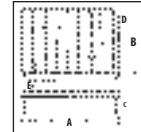

CB497
8 to 32 compartments
24 partitions provided
Wt.: 3.5 lbs.

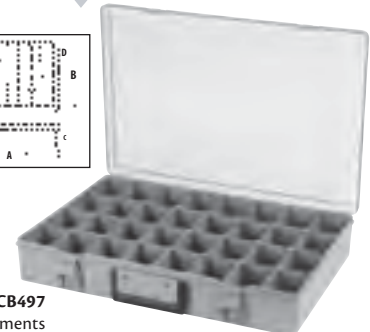

Flambeau

SMALL CASES

15" L x 11 3/4" W

- Small Satchel store and organize large, medium, small and flat parts, removable partitions
- See-through lids allow quick identification of contents
- Copolymer resins that will not rust or dent
- Brass pinned hinges provide strength and durability
- Divided style (CB499) or double case (CB500) with two cases sonically welded back to back
- Can be stored flat or upright

- A: 15"
- B: 2"
- C: 3 1/8"
- D: 2 1/8"
- E: 2"
- F: 11 3/4"
- G: 2 1/2"

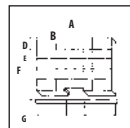

CB499
9 to 24 compartments
Wt. 2.9 lbs.



- A: 15"
- B: 2"
- C: 3 1/8"
- D: 2 1/8"
- E: 2"
- F: 11 3/4"
- G: 5"

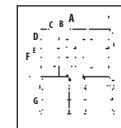

CB500
18 to 48 compartments
Wt. 5.8 lbs.

Flambeau



STEEL COMPARTMENT CASES

COMPARTMENT STEEL SCOOP BOXES

- Manufactured of prime cold-rolled steel
- Fixed compartment boxes
- Choose from between 8 and 32 fixed compartment boxes
- Small box dimensions: 13 3/8" W x 9 1/4" D x 2" H
- Large box dimensions: 18" W x 12" D x 3" H
- Finished in rust and acid resistant baked enamel
- Boxes have inserts of high impact plastic
- Inserts have rounded scoops, making it easy to remove small parts
- All models have covers designed to stay open
- See chart below for box configurations

DURHAM MFG®
Est. 1922



FIXED COMPARTMENT CONFIGURATIONS, ORDER BY NUMBER OF COMPARTMENTS

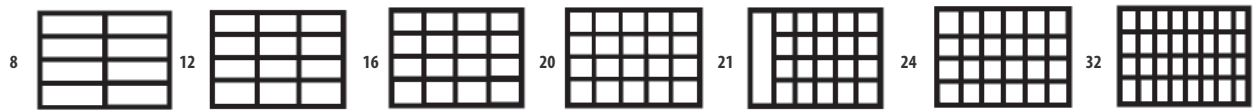

LARGE COMPARTMENT BOXES 18" W x 12" D x 3" H

SMALL COMPARTMENT BOXES 13 3/8" W x 9 1/4" D x 2" H

Number of Compartments	Model No.	Wt. lbs.	Model No.	Wt. lbs.
8	-	-	CB032	4
12	CA986	8	CB015	4
16	CA989	8	CB017	4
20	CA992	8	CB023	4
21	CA995	8	CB026	4
24	CA997	8	CB029	4
32	CB002	8	-	-

COMPARTMENT BOX CABINETS

- Carriages extend 100% of the drawers depth for easy access to parts
- Flexibility of removable drawers and a large selection of drawer configurations
- Drawer cabinet may be mounted on a raised base
- Cabinets are available for both the small and large drawer sizes
- Boxes and base are sold separately
- Optional locking hinge (CB037) prevents boxes from sliding out during transport

DURHAM MFG®
Est. 1922

Model No.	Dimensions			For Box	Drawer Capacity	Wt. lbs.
	W"	x D"	x H"			
CA963	20	x 15 3/4	x 8 1/8	Large	2	20
CA965	20	x 15 3/4	x 15	Large	4	34
CA972	15 1/4	x 11 3/4	x 11 1/4	Small	4	22
CA975	15 1/4	x 11 3/4	x 16 3/8	Small	6	32
CB037	Optional Locking Hinge for CA972			-	-	-
CB038	Optional Locking Hinge for CA965 and CA975			-	-	-



Cabinet and boxes sold separately

CA965

ADJUSTABLE COMPARTMENT BOXES

- Adjustable drawers provide the added flexibility of arranging your drawers according to your changing needs
- Removable dividers can be "slotted" into place or removed altogether



CA977

DURHAM MFG®
Est. 1922

Model No.	Dimensions			Description	Wt. lbs.
	W"	x D"	x H"		
CA977	18	x 12	x 3	Large	8
CA979	13 3/8	x 9 1/4	x 2	Small	4

CABINET BASES

- Cabinet bases raise your cabinet/drawer combination 12" off of the floor or workbench
- Models are available to adapt to both small and large drawer size cabinets



CA980

DURHAM MFG®
Est. 1922

Model No.	Overall Dimensions			For Box	Wt. lbs.
	W"	x D"	x H"		
CA980	20 3/8	x 16	x 15 1/8	Large	13
CA983	15 1/2	x 12 1/8	x 15 1/8	Small	12

STACKBIN® CONTAINERS

STEEL STACKBINS®

- Hopper-front steel Stackbins® are available with capacities from 70 cubic inches up to 5100 cubic inches
- They may be easily stacked one on top of another, or housed in steel Stackracks®, together with Stackracks® base allowing lower units to be removed without disturbing units stacked above them
- Standard blue baked enamel finish

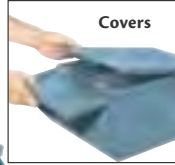

STACKBIN

Model No.	Capacity Cu. in.	Dimensions W" x D" x H"	Wt. lbs.	Top Cover Model No.	Front Cover Model No.
CA765	70	4 1/2 x 8 x 4 1/2	1.8	-	-
CA766	200	5 1/2 x 12 x 4 1/2	3	CD369	CD368
CA767	500	7 1/2 x 15 1/2 x 6	5.5	CD370	CA734
CA768	900	9 x 18 3/4 x 7 1/2	9	CA706	CA735
CA772	1400	10 x 24 x 8	12	CA710	CA739
CA769	1600	12 x 20 1/2 x 9 1/2	12.5	CA707	CA736
CA770	2800	15 x 24 x 11	20.5	CA708	CA737
CA771	5100	18 x 30 x 12	30	CA709	CA738

PLASTIC STACKBINS®

- Available in two types and sizes of plastic
- **CB310** and **CB311** are molded of polypropylene and have a capacity of 200 cubic inches
- **CB314** and **CB315** are molded of polyethylene and have a capacity of 1600 cu. in.
- The exclusive interlocking front bar prevents the bins from spreading under heavy loads

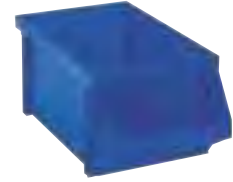

STACKBIN

Model No.	Wt. lbs.
Blue	Grey
5 1/2" W X 12" D X 4 1/2" H	
CB310	CB311
12" W X 20 1/2" D X 9 1/2" H	
CB314	CB315
4	

STACKRACKS®

- Stackracks® are designed to be teamed up with Stackbins® to create a heavy-duty storage system
- Stackracks® allow for bins to be removed easily from a setup
- Can support any weight that fits within the cube of the coinciding container
- Easily stack together without tools or fasteners and feature Stackbins' patented locking system
- Can be reconfigured or added to at any time

Shown with 10 - CA769 bins, 10 - CA776 single Stackracks® and 1 - CA693 Base 2 bins wide



STACKBIN

STACKRACKS®

Model No.	Description	Wt. lbs.
CD447	For Bin CA765	3.5
CA773	For Bin CA766	4
CA774	For Bin CA767	5.5
CA775	For Bin CA768	8.5
CA780	For Bin CA772	9
CA776	For Bin CA769	10
CA778	For Bin CA770	12
CA779	For Bin CA771	14

STACKRACKS® COVERS

Model No.	Description
CA715	For CA775
CA730	For CA780
CA720	For CA776
CA724	For CA778
CA727	For CA779

12" HIGH BASES

- Can be butt-up to each other to make continuous rows of storage bins
- Bases are made specifically for each size steel container
- 14-gauge legs and supports
- Spot welded
- Capacity: 1000 lbs.

Model No.	Description
1-BIN WIDE	
CA687	For Stackracks® CA775
CA692	For Stackracks® CA776
CA696	For Stackracks® CA778
CA699	For Stackracks® CA779
2-BIN WIDE	
CD448	For Stackracks® CA774
CA688	For Stackracks® CA775
CA703	For Stackracks® CA780
CA693	For Stackracks® CA776
CA697	For Stackracks® CA778
CA700	For Stackracks® CA779
3-BIN WIDE	
CD449	For Stackracks® CA774
CA689	For Stackracks® CA775
CA704	For Stackracks® CA780
CA694	For Stackracks® CA776

SECTIONAL STACKBINS® SYSTEMS

- Sectional Stackbin® units are an economical alternative to standard Stackbins®
- Individual compartments are created from a standard 37" wide unit divided by welded steel partitions
- Each unit may be stacked on a larger, or similar sized unit, with covers and bases to complete the unit

Model No.	Dimensions W" x D" x H"	Bins in Section	Wt. lbs.
SECTIONAL STACKBINS®			
CA786*	37 x 8 x 4 1/2	8	11.0
CA787*	37 x 12 x 4 1/2	6	13.8
CA788	37 x 15 1/2 x 6	5	20.0
CA789	37 x 18 3/4 x 7 1/2	4	29.0
CA790	37 x 20 1/2 x 9 1/2	3	35.0
CA791	37 x 24 x 11	2	40.0

* No bases available

STACKBIN



CA791

Model No.	Description	Model No.	Description
SECTIONAL BASES		SECTIONAL COVERS	
CA793	For CA788	CA797	For CA786
CA794	For CA789	CA798	For CA787
CA795	For CA790	CA799	For CA788
CA796	For CA791	CA800	For CA789
		CA801	For CA790
		CA802	For CA791

PRE-ENGINEERED SECTIONAL SYSTEMS

- Complete with sectional Stackbin® 6" high base and top cover
- 5000-lb. stocking capacity

Model No.	Description	Wt. lbs.
USING CA788 SECTIONAL STACKBINS®		
CD354	7 Row Unit w/35 Compartments	136.5
CD355	8 Row Unit w/40 Compartments	156
USING CA789 SECTIONAL STACKBINS®		
CD356	6 Row Unit w/24 Compartments	174
CD357	7 Row Unit w/28 Compartments	226.5
USING CA790 SECTIONAL STACKBINS®		
CD358	5 Row Unit w/15 Compartments	200
CD359	6 Row Unit w/18 Compartments	235
USING CA791 SECTIONAL STACKBINS®		
CD360	4 Row Unit w/8 Compartments	183.5
CD361	5 Row Unit w/10 Compartments	222.5

STACKBIN



CD361

BULK STACKING CONTAINERS

- Heavy-duty all-welded construction
- Mesh containers use 2" x 2" x 10 gauge wire mesh
- All containers use a 13-gauge corrugated sheet steel base
- 2" x 2" x 3/16" angle posts
- 4-way fork truck entry with 4" underclearance
- Available with one drop gate or fully enclosed sides
- Height: 24" inside, 30" overall
- Stackable up to five high
- Other sizes are available
- Painted durable Kleton blue



Model No.	Description	Dimensions W" x L"	Capacity lbs.	Wt. lbs.
MESH CONTAINERS				
CF449	Fully Enclosed	34 1/2 x 40 1/2	3000	125
CF450	One Drop Gate	34 1/2 x 40 1/2	3000	130
CF451	Fully Enclosed	40 1/2 x 48 1/2	3000	150
CF452	One Drop Gate	40 1/2 x 48 1/2	3000	160
SHEET CONTAINERS				
CF453	Fully Enclosed	34 1/2 x 40 1/2	3500	150
CF454	One Drop Gate	34 1/2 x 40 1/2	3500	150
CF455	Fully Enclosed	40 1/2 x 48 1/2	3500	185
CF456	One Drop Gate	40 1/2 x 48 1/2	3500	185
CORRUGATED CONTAINERS				
CF457	Fully Enclosed	34 1/2 x 40 1/2	4500	160
CF458	One Drop Gate	34 1/2 x 40 1/2	4500	160
CF459	Fully Enclosed	40 1/2 x 48 1/2	4500	195
CF460	One Drop Gate	40 1/2 x 48 1/2	4500	195

COLLAPSIBLE STRUCTURAL POLYETHYLENE CONTAINERS

- Sturdy, long-lived and quick to erect or knock down
- Fully recyclable containers replace tons of corrugated paper and wood packaging waste
- These space-efficient collapsible containers cube out trailers and ISO containers
- Collapsible to one-third their height for space-saving return shipment
- Stack safely, full or folded to create warehouse space without racking
- Models featured below include two drop gates (one drop and no drop also available)
- Capacity: 2000 lbs. or 1500 lbs.



ORBIS

2000 lbs. Capacity			1500 lbs. Capacity			Ext. Dimensions L" x W" x H"
Model No.	Wt. lbs.	Cover Model No.	Model No.	Wt. lbs.	Cover Model No.	
CF447	119	CC171	CF490	113	CF493	48 x 45 x 25
CF448	145	CC171	CF491	126	CF493	48 x 45 x 34
CF445	159	CC170	CF487	137	CF489	48 x 40 x 34
CF446	169	CC170	CF488	152	CF489	48 x 40 x 39
CF443	68	CC169	CF483	65	CF486	30 x 32 x 25
CF444	85	CC169	CF484	81	CF486	30 x 32 x 34

F.O.B Mississauga, ON

OPEN MESH CONTAINERS

- Rugged construction ensures long-lasting, trouble-free service
- 3/4" - 13 gauge expanded metal mesh panels
- Two half drop gates
- 4-way fork truck access
- 4 1/4" underclearance
- Overall dimensions: 34 1/2" W x 40 1/2" L x 32 1/4" H
- Stackable up to five high
- 15 cu.ft. capacity
- Deck capacity: 2500 lbs. mesh deck, 3000 lbs. sheet metal deck
- Blue enamel finish



Model No.	Style	Wt. lbs.
CA397	Mesh Deck	105
CA398	Sheet Metal Deck	114
CA368	Replacement Foot	0.72

STACKING RACKS

- Rugged all-welded 2" square tubing steel construction
- Utilise warehouse airspace and lower the chances of damage that is associated with bulk stacking
- Designed for storage of loose and palletised goods
- Holds 4000 lbs per rack and can be stacked four high
- Posts and bases are sold separately
- Durable Kleton blue enamel finish

Model No.	Inside Dim. W" x D"	Overall Dim. W" x D"	Wt. lbs.
OPEN BASE			
RL414	38 x 44	42 x 48	85
RL415	44 x 48	48 x 48	90
CLOSED BASE			
RL416	38 x 44	42 x 48	110
RL417	44 x 44	48 x 48	115



ACCESSORIES

Model No.	Description	Overall Dim. W" x H"	Wt. lbs.
RL418	42" Side Rail	42 x 48	30
RL419	48" Side Rail	48 x 48	32
RL420	42" Upright Post-Pack of 4	2 x 42	35
RL421	48" Upright Post-Pack of 4	2 x 48	40
RL422	60" Upright Post-Pack of 4	2 x 60	50

COLLAPSIBLE WIRE CONTAINERS

- Welded, square mesh wire allows full visibility and excellent ventilation
- Foldable and constructed of durable 3-gauge wire
- 4-way entry for easy use with lift trucks
- Convenient drop gate design for easy access to products
- Safety rating plates with static load capacity and static load height
- Stack up to four high
- 4" under clearance



Model No.	Dimensions W" x D" x H"	Usable Height"	Drop Gate	Mesh Dim."	Cap. lbs.	Wt. lbs.
CF462	20 x 32 x 21	16	32" Side	1 x 1	1000	43
CF463	20 x 32 x 21	16	32" Side	1/2 x 1/2	1000	55
CF464	32 x 40 x 34 1/2	28	40" Side	2 x 2	4000	122
CF465	40 x 48 x 30 1/2	24	48" Side	2 x 2	4000	150
CF466	40 x 48 x 36 1/2	30	48" Side	2 x 2	4000	163
CF467	40 x 48 x 36 1/2	30	40" End	2 x 2	4000	163
CF468	40 x 48 x 42 1/2	36	48" Side	2 x 2	4000	176

WIRE SHELVING

CHROMATE WIRE SHELVING

- Heavy-gauge shelves with open wire design minimize dust, improve air circulation and provide greater visibility of stored items
- Post's circular grooves combined with tapered plastic split sleeves allow for assembly in minutes with no special tools
- Shelf ribs run front to back allowing items to slide on and off shelves smoothly
- Shelves can be adjusted at precise 1" intervals
- Posts are double grooved every 8" and numbered for easy adjustment
- Adjustable feet compensate for surface irregularities
- Stationary unit's total capacity should not exceed 2000-lb.
- Shipped knocked down
- NSF certified



POSTS

Model No.	Height"	Wt. lbs.
RL611	33	4
RL330	54	6.3
RL331	63	7
RL332	74	8
RL333	86	8.8

WIRE SHELVES

Model No.	Dimensions			Cap lbs. /Shelf*	Wt. lbs.
	W"	x	D"		
RL606	30	x	14	800	7.5
RL607	36	x	14	800	8.25
RL608	48	x	14	800	10.5
RL609	60	x	14	600	14.25
RL610	72	x	14	600	17.5
RL035	30	x	18	800	8.5
RL036	36	x	18	800	9.75
RL037	48	x	18	800	12.5
RL038	60	x	18	600	18
RL039	72	x	18	600	20.5
RL040	36	x	24	800	13.25
RL041	48	x	24	800	16.25
RL042	60	x	24	600	21.5
RL043	72	x	24	600	27

* Evenly distributed weight

ACCESSORIES

Model No.	Description	Wt. lbs.
RL048	Caster, 5", No Brake	2.8
RL049	Caster, 5", With Brake	2.7
RL050	Divider For Shelf, 18"	1.7
RL051	Divider For Shelf, 24"	2.2
RL052	Handle 18" - Can Only Be Used With Utility Carts	3.9
RL053	Handle 24" - Can Only Be Used With Utility Carts	4.4
RL054	Split Sleeves, Black 4 Pc/Bag	0.1
RL055	S-Hook For Attaching Add-On	0.1
RL056	Leveling Feet (Die Cast And Foot Bolt)	0.2
RL057	Die Cast For Leveling Feet	0.1
RL058	Foot Bolt For Leveling Feet	0.1
RL612	Direct Wall Mount, Single Shelf Support, 14"	2
RL613	Direct Wall Mount, Double Shelf Support, 14"	3.5
RL898	Direct Wall Mount, Single Shelf Support, 18"	1.75
RL899	Direct Wall Mount, Double Shelf Support, 18"	3.25
RL900	Direct Wall Mount, Single Shelf Support, 24"	1.9
RL901	Direct Wall Mount, Double Shelf Support, 24"	3.56
RL614	Ledge For Shelf, 14"	0.6
RL615	Ledge For Shelf, 18"	0.75
RL616	Ledge For Shelf, 24"	1
RL617	Ledge For Shelf, 30"	2
RL618	Ledge For Shelf, 36"	2.5
RL619	Ledge For Shelf, 48"	3.5
RL620	Ledge For Shelf, 60"	3.75
RL621	Ledge For Shelf, 72"	4



RL054

Use 5 hooks to eliminate two posts per adjacent shelf. Two required per shelf.



RL055



RL050
Divider



RL612
Direct Wall Mount,
Single Shelf Support



RL614
Ledge for Shelf

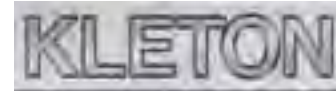

COMPLETE SHELVING UNITS

Model No.	Type	Dimensions			Cap lbs /Shelf*	Wt. lbs.		
		W"	x	D"				
4 SHELVES								
RL907	Starter	30	x	14	x	63	800	39
RL908	Add-On	30	x	14	x	63	800	32
RL632	Starter	36	x	14	x	63	800	42.6
RL633	Add-On	36	x	14	x	63	800	35.5
RL634	Starter	48	x	14	x	63	800	49
RL635	Add-On	48	x	14	x	63	800	42
RL636	Starter	60	x	14	x	63	600	64.75
RL637	Add-On	60	x	14	x	63	600	57.75
RL638	Starter	72	x	14	x	63	600	71.5
RL639	Add-On	72	x	14	x	63	600	64.4
RL059	Starter	36	x	18	x	63	800	48
RL060	Add-On	36	x	18	x	63	800	35
RL061	Starter	48	x	18	x	63	800	58
RL062	Add-On	48	x	18	x	63	800	53.5
RL063	Starter	60	x	18	x	63	600	81
RL064	Add-On	60	x	18	x	63	600	76.5
RL065	Starter	72	x	18	x	63	600	91
RL066	Add-On	72	x	18	x	63	600	86.5
RL067	Starter	36	x	24	x	63	800	62
RL068	Add-On	36	x	24	x	63	800	57.5
RL069	Starter	48	x	24	x	63	800	74
RL070	Add-On	48	x	24	x	63	800	69.5
RL071	Starter	60	x	24	x	63	600	95
RL072	Add-On	60	x	24	x	63	600	90.5
RL073	Starter	72	x	24	x	63	600	117
RL074	Add-On	72	x	24	x	63	600	112.5
5 SHELVES								
RL909	Starter	30	x	14	x	74	800	47
RL910	Add-On	30	x	14	x	74	800	39
RL640	Starter	36	x	14	x	74	800	51
RL641	Add-On	36	x	14	x	74	800	43.46
RL642	Starter	48	x	14	x	74	800	59
RL643	Add-On	48	x	14	x	74	800	42.8
RL644	Starter	60	x	14	x	74	600	78.78
RL645	Add-On	60	x	14	x	74	600	71
RL646	Starter	72	x	14	x	74	600	87.3
RL647	Add-On	72	x	14	x	74	600	79.5
RL075	Starter	36	x	18	x	74	800	67.75
RL076	Add-On	36	x	18	x	74	800	58.25
RL077	Starter	48	x	18	x	74	800	80.25
RL078	Add-On	48	x	18	x	74	800	70.75
RL079	Starter	60	x	18	x	74	600	109
RL080	Add-On	60	x	18	x	74	600	99.5
RL081	Starter	72	x	18	x	74	600	121.5
RL082	Add-On	72	x	18	x	74	600	112
RL083	Starter	36	x	24	x	74	800	85.25
RL084	Add-On	36	x	24	x	74	800	75.75
RL085	Starter	48	x	24	x	74	800	100.25
RL086	Add-On	48	x	24	x	74	800	90.75
RL087	Starter	60	x	24	x	74	600	126.5
RL088	Add-On	60	x	24	x	74	600	117
RL089	Starter	72	x	24	x	74	600	154
RL090	Add-On	72	x	24	x	74	600	144.5
RL448	Starter	36	x	18	x	86	800	62
RL449	Add-On	36	x	18	x	86	800	53
RL450	Starter	48	x	18	x	86	800	69
RL451	Add-On	48	x	18	x	86	800	60
RL452	Starter	60	x	18	x	86	600	91.5
RL453	Add-On	60	x	18	x	86	600	82
RL454	Starter	72	x	18	x	86	600	96
RL455	Add-On	72	x	18	x	86	600	87
RL456	Starter	36	x	24	x	86	800	74
RL457	Add-On	36	x	24	x	86	800	65
RL458	Starter	48	x	24	x	86	800	90
RL459	Add-On	48	x	24	x	86	800	80
RL460	Starter	60	x	24	x	86	600	107
RL461	Add-On	60	x	24	x	86	600	97
RL462	Starter	72	x	24	x	86	600	129
RL463	Add-On	72	x	24	x	86	600	120

* Evenly distributed weight

WIRE SHELVING UNITS WITH STORAGE BINS

Same great features as the Kleton chrome wire shelving, but with the added convenience of heavy-duty storage bins.

- Adjustable chrome wire shelves
- Wire shelving resists corrosion and provides greater visibility to stored parts
- Wire shelves prevent build up of dust and dirt
- Bins are unaffected by oil, alkaline, and most acids
- Ideal in production or for parts storage

Model No.	No. of Shelves	Shelving Dim.			Bin Dim.					No. of Bins	Colour
		W"	D"	H"	W"	D"	H"	W"	D"		
RL823	5	36	24	74	15 1/2	25	13	8	Blue		
RL824	5	36	24	74	15 1/2	25	13	8	Yellow		
RL825	5	36	24	74	15 1/2	25	13	8	Green		
RL826	5	36	24	74	15 1/2	25	13	8	Red		
RL835	5	48	24	74	7 7/8	17 11/16	7	4	Blue		
					11 13/16	17 11/16	7	7	Blue		
					15 1/2	25	13	6	Blue		
RL836	5	48	24	74	7 7/8	17 11/16	7	4	Yellow		
					11 13/16	17 11/16	7	7	Yellow		
					15 1/2	25	13	6	Yellow		
RL837	5	48	24	74	7 7/8	17 11/16	7	4	Green		
					11 13/16	17 11/16	7	7	Green		
					15 1/2	25	13	6	Green		
RL838	5	48	24	74	7 7/8	17 11/16	7	4	Red		
					11 13/16	17 11/16	7	7	Red		
					15 1/2	25	13	6	Red		



RL826

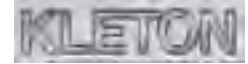

RL837

GREEN EPOXY FINISH WIRE SHELVING

- Ideal for use in wet environments
- Superior rust resistance
- Designed to minimize dust, improve air circulation, and provide greater visibility of stored items
- Post's circular grooves combined with tapered plastic sleeves allow for assembly in minutes with no special tools
- Shelf ribs run front to back allowing items to slide on and off shelves smoothly
- Shelves can be adjusted at precise 1" intervals
- Posts are double grooved every 8" and numbered for easy adjustment
- Adjustable feet compensate for surface irregularities
- Stationary unit's total capacity should not exceed 2000 lbs.
- NSF certified

COMPLETE SHELVING UNITS

Model No.	Type	Dimensions			Cap. lbs. /Shelf
		W"	D"	H"	
4 SHELVES					
RL648	Starter	36	18	63	800
RL649	Add-On	36	18	63	800
RL650	Starter	48	18	63	800
RL651	Add-On	48	18	63	800
RL652	Starter	60	18	63	600
RL653	Add-On	60	18	63	600
RL654	Starter	72	18	63	600
RL655	Add-On	72	18	63	600
RL656	Starter	36	24	63	800
RL657	Add-On	36	24	63	800
RL658	Starter	48	24	63	800
RL659	Add-On	48	24	63	800
RL660	Starter	60	24	63	600
RL661	Add-On	60	24	63	600
5 SHELVES					
RL662	Starter	36	18	74	800
RL663	Add-On	36	18	74	800
RL664	Starter	48	18	74	800
RL665	Add-On	48	18	74	800
RL666	Starter	60	18	74	600
RL667	Add-On	60	18	74	600
RL668	Starter	72	18	74	600
RL669	Add-On	72	18	74	600
RL670	Starter	36	24	74	800
RL671	Add-On	36	24	74	800
RL672	Starter	48	24	74	800
RL673	Add-On	48	24	74	800
RL674	Starter	60	24	74	600
RL675	Add-On	60	24	74	600



RL648

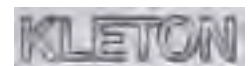

POSTS

Model No.	Height"
RL629	63
RL630	74
RL631	86

WIRE SHELVES

Model No.	Dimensions W" x D"	Cap. lbs. /Shelf
RL622	36 x 18	800
RL623	48 x 18	800
RL624	60 x 18	600
RL625	72 x 18	600
RL626	36 x 24	800
RL627	48 x 24	800
RL628	60 x 24	600

WIRE SHELF CARTS

GREEN EPOXY WIRE SHELF CARTS

- Ideal for use in wet environments
- Superior rust resistance
- Designed to minimize dust, improve air circulation, and provide greater visibility of stored items
- Shelves can be adjusted quickly and easily
- Strong and versatile
- **Includes:** 5" resilient rubber casters (two swivel, two with brake)
- Capacity: 600 lbs. evenly distributed
- 1-year limited warranty
- Shipped knocked-down
- NSF certified



Model No.	Dimensions			Wt. lbs.
	W"	x D"	x H"	
4 SHELVES				
RL803	36	x 18	x 74	64
RL804	48	x 18	x 74	74
RL805	60	x 18	x 74	94
RL806	36	x 24	x 74	78
RL807	48	x 24	x 74	90
RL808	60	x 24	x 74	110
5 SHELVES				
RL809	36	x 18	x 86	68
RL810	48	x 18	x 86	78
RL811	60	x 18	x 86	98
RL812	36	x 24	x 86	82
RL813	48	x 24	x 86	94
RL814	60	x 24	x 86	114



WIRE SHELF CARTS

- Open-wire shelf design minimizes dust and increases air circulation and visibility
- High quality chromate shelves and posts prevent corrosion
- Shelves can be adjusted easily and quickly
- Capacity: 600 lbs. evenly distributed weight
- **Includes:** 5" resilient rubber casters (two swivel, two with brake)
- 1-year limited warranty
- Shipped knocked down
- NSF certified



Model No.	Dimensions			Wt. lbs.
	W"	x D"	x H"	
4 SHELVES				
RL600	36	x 18	x 63	56
RL601	48	x 18	x 63	65
RL602	60	x 18	x 63	83
MJ527	36	x 18	x 74	64
MJ528	48	x 18	x 74	74
MJ529	60	x 18	x 74	94
RL603	36	x 24	x 63	69
RL604	48	x 24	x 63	81
RL605	60	x 24	x 63	95
MJ530	36	x 24	x 74	78
MJ531	48	x 24	x 74	90
MJ532	60	x 24	x 74	110
5 SHELVES				
MJ533	36	x 18	x 86	68
MJ534	48	x 18	x 86	78
MJ535	60	x 18	x 86	98
MJ536	36	x 24	x 86	82
MJ537	48	x 24	x 86	94
MJ538	60	x 24	x 86	114



STANDARD DUTY UTILITY CARTS

- Durable, dependable transport solution that is easy to manoeuvre
- Highly rigid construction lets you easily adjust at 1" increments
- Durable chromate handles, shelves and posts
- Capacity: 600 lbs. evenly distributed weight
- **Includes:** Two handles, indicated number of shelves, and casters
- 1-year limited warranty
- Shipped knocked down
- NSF certified



Model No.	Dimensions			Wt. lbs.
	W"	x D"	x H"	
2 SHELVES				
MK781	30	x 18	x 39	36.5
MK782	36	x 18	x 39	40.25
MK783	48	x 18	x 39	44.75
MK784	60	x 18	x 39	54
MK785	36	x 24	x 39	47.75
MK786	48	x 24	x 39	53.75
MK787	60	x 24	x 39	63.5
3 SHELVES				
MJ539	30	x 18	x 39	45
MJ540	36	x 18	x 39	50
MJ541	48	x 18	x 39	57
MJ542	60	x 18	x 39	72
MJ543	36	x 24	x 39	61
MJ544	48	x 24	x 39	70
MJ545	60	x 24	x 39	85

PUSH CARTS

- Durable, dependable transport solution
- Easy maneuverability
- Shelves can be adjusted quickly and easily
- Capacity: 600 lbs. evenly distributed
- 1-year limited warranty
- Shipped knocked down
- NSF certified



Model No.	Dimensions			Wt. lbs.
	W"	x D"	x H"	
4 SHELVES				
RL914	30	x 14	x 54	
RL915	36	x 14	x 54	
RL916	48	x 14	x 54	
RL917	60	x 14	x 54	
5 SHELVES				
RL918	30	x 14	x 54	
RL919	36	x 14	x 54	
RL920	48	x 14	x 54	
RL921	60	x 14	x 54	



SLOTTED ANGLE SHELVING

- Ideal for shelving and storage systems, workbenches, tubing storage, protective framing around machinery, platforms around assembly projects, etc.
- Choose from the various components available, or pre-configured shelf units
- Unique boltless clip design allows for adjustability of shelves easily and effortlessly
- To ensure stability, it is recommended that three shelf levels are bolted when using boltless clips
- All shelving units include four steel posts (1 3/8" x 1 3/8" slotted angle), galvanised shelves, galvanised panels (for closed units), plastic feet and all necessary hardware
- Assembly required



RH701



RH774

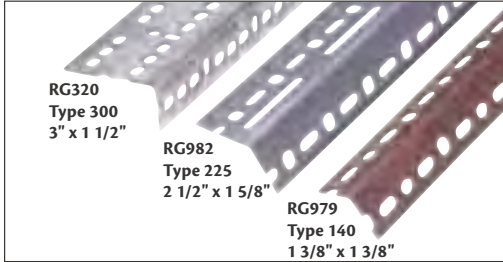

6 SHELVES/72" POST		7 SHELVES/84" POST		8 SHELVES/96" POST		Dimensions W" x L"
OPEN Model No.	CLOSED Model No.	OPEN Model No.	CLOSED Model No.	OPEN Model No.	CLOSED Model No.	
RH701	RH774	RH707	RH780	RH713	RH786	12 x 36
RH702	RH775	RH708	RH781	RH714	RH787	18 x 36
RH703	RH776	RH709	RH782	RH715	RH788	24 x 36
RH704	RH777	RH710	RH783	RH716	RH789	12 x 48
RH705	RH778	RH711	RH784	RH717	RH790	18 x 48
RH706	RH779	RH712	RH785	RH718	RH791	24 x 48

Model No.	Dimensions W" x D"	Angle Length'	Steel Gauge	Type	UDL*	Wt. lbs.
SLOTTED ANGLE POSTS						
RG979	1 3/8 x 1 3/8	8	14	140	-	6
RG980	1 3/8 x 1 3/8	10	14	140	-	7
RG981	1 3/8 x 1 3/8	12	14	140	-	8.5
RG982	2 1/2 x 1 5/8	8	14	225	-	9
RG983	2 1/2 x 1 5/8	10	14	225	-	11
RG984	2 1/2 x 1 5/8	12	14	225	-	13
RG320**	3 x 1 1/2	10	12	300	-	14
RG321**	3 x 1 1/2	12	12	300	-	17
GALVANISED SHELVES						
RG985	12 x 36	-	20	-	450	7
RG986	15 x 36	-	20	-	450	8.3
RG987	18 x 36	-	20	-	450	9.6
RG988	24 x 36	-	20	-	450	12.2
RG989	32 x 42	-	18	-	300	23.7
RG990	12 x 48	-	20	-	350	9.2
RG991	15 x 48	-	20	-	350	10.9
RG992	18 x 48	-	20	-	350	12.6
RG993	24 x 48	-	19	-	400	18.5

*UDL: Maximum uniformly distributed load allowance where maximum shelf deflection is fully recovered when load is removed.
**Galvanised steel

Model No.	Dim. W" x H"	Steel Gauge	Wt. lbs.
GALVANISED SIDE PANELS			
RH759	12 x 72	24	7
RH760	18 x 72	24	11
RH761	24 x 72	24	15
RH762	12 x 84	24	8
RH763	18 x 84	24	13
RH764	24 x 84	24	17
RH765	12 x 96	24	10
RH766	18 x 96	24	14
RH767	24 x 96	24	19

Model No.	Dim. W" x H"	Steel Gauge	Wt. lbs.
GALVANISED BACK PANELS			
RH768	36 x 72	24	22
RH769	48 x 72	24	29
RH770	36 x 84	24	25
RH771	48 x 84	24	34
RH772	36 x 96	24	29
RH773	48 x 96	24	38
GALVANISED KICK PANELS			
RH792	36 x 3	20	1.3
RH793	48 x 3	20	1.7

Steel slotted angle allows you to design and build anything to your own specifications:

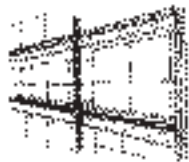

Metal Decking

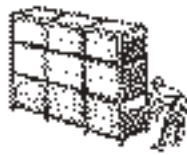

Tubing Storage



Overhead Storage



Overhead Storage



Wide Storage

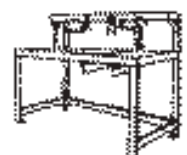

Special Work Benches

SLOTTED ANGLE ACCESSORIES

CORNER GUSSET PLATES

- Add strength and rigidity to your slotted angle assembly
- 3" W x 3" L

PLASTIC FEET

- 1 3/8" x 1 3/8" angle posts



RG994



RG996



RL344

ACCESSORIES

Model No.	Description	Wt. lbs.
RG994	Corner Gusset Plate 3"	0.70
RG995	Nut and Bolt	0.05
RG996	Boltless Shelf Clip	0.60
RL344*	Plastic Foot for Single Post	0.02
RG238*	Plastic Foot for Double T-Post	0.03

*For 1 3/8" X 1 3/8" posts

SHELVING

BOLTLESS SHELVING UNITS

- Adjustable shelving system that provides high strength, yet economical storage capacity for your needs
- This system uses an innovative shelf clip, which slips into a slotted "T" post and is immediate ready to receive a shelf
- No-Bolt design reduces up to 80% of installation time
- Colour: Grey
- Ships knocked down



RK550
"T" Post

RK565
RK472
Side and back
braces



RK521
End Panels

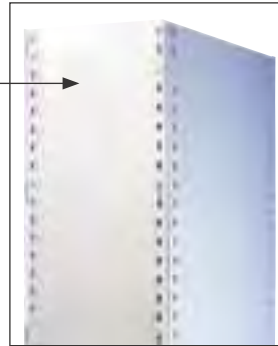

RK483
Base Plate

"T" POSTS

- For open style shelving includes slots every 1" for shelf or brace installation
- 1 1/2" x 2" x 1/8" double-formed steel in a "T" style with a smooth unperforated face
- Capacity: 11000 lbs.

Model No.	Height	Wt. lbs.
RK549	3'4"	4
RK550	6'4"	8
RK551	7'4"	9
RK548	8'4"	10
RK544	9'4"	11



RK552
Shelves



RK470
Back panel

SHELVES

- Shelves are easily installed using four clips
- Constructed from 18-gauge steel
- 4 clips included with each shelf

Model No.	Dimensions W" x D"	Capacity lbs.	Wt. lbs.
RK552	36 x 12	630	8
RK553	42 x 12	480	9
RK554	48 x 12	315	10.5
RK555	36 x 15	630	9.75
RK556	42 x 15	480	11.5
RK557	48 x 15	315	12.5
RK558	36 x 18	630	11.5
RK559	42 x 18	480	13
RK560	48 x 18	315	15
RK561	36 x 24	630	14.75
RK562	42 x 24	480	16.5
RK563	48 x 24	315	19
RK564	36 x 30	560	18

DOORS

- Lockable swinging doors installs easily on closed style shelving
- Includes RN032 base plate

Model No.	Dimensions W x H	Wt. lbs.
RN028	36" x 6'4"	43
RN029	36" x 7'4"	50
RN032*	Replacement Base Plate	2

*Only for units with doors

BASE PLATES

- Install at floor level to close openings

Model No.	Dimensions W" x H"	Wt. lbs.
RK483	36 x 3	2
RK484	42 x 3	2.25
RK485	48 x 3	2.5



RN028
Doors

END PANELS

- For closed style shelving
- Each panel incorporates two slotted post

Model No.	Dimensions D x H	Wt. lbs.
RK521	12" x 3'4"	10.5
RK522	12" x 6'4"	20.75
RK523	12" x 7'4"	23.5
RK520	12" x 8'4"	26.25
RK525	15" x 3'4"	11.5
RK526	15" x 6'4"	22.5
RK527	15" x 7'4"	25.5
RK524	15" x 8'4"	28.5
RK537	18" x 6'4"	24
RK538	18" x 7'4"	27
RK519	18" x 8'4"	30.5
RK529	24" x 3'4"	14
RK530	24" x 6'4"	27
RK531	24" x 7'4"	31
RK528	24" x 8'4"	34.5
RK532	30" x 8'4"	38.75

BACK PANELS

- For closed style shelving
- Attach easily to end panels using back brackets provided

Model No.	Dimensions W x H	Wt. lbs.
RK470	36" x 6'4"	19
RK471	36" x 7'4"	22
RK460	36" x 8'4"	25
RK465	42" x 7'4"	25.5
RK462	42" x 8'4"	29
RK947	48" x 3'4"	13.5
RK468	48" x 6'4"	25.5
RK469	48" x 7'4"	29.5
RK466	48" x 8'4"	33.5

SIDE & BACK BRACES

- Provide stability to open style shelving units
- Sold in pairs

Model No.	Description	Wt. lbs.
RK472	Back Brace	4
RK565	Side Brace	2



RK503
Dividers



RK540
Label Holders

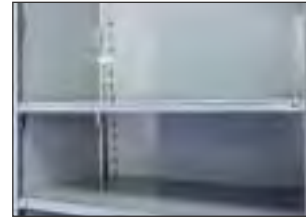

RK475
Bin Front



RK566
Shelf Boxes



RC453
Gusset



RL756
48" Hanger Bar



RK949
Foot Plate

DIVIDERS

- Separate shelves into bin compartments
- Constructed of 20 gauge steel

Model No.	Dimensions			Wt. lbs.
	D"	x	H"	
RK503	12	x	6	0.5
RK504	15	x	6	0.75
RK505	18	x	6	1
RK506	24	x	6	1.5
RK507	12	x	8	0.75
RK508	15	x	8	1
RK509	18	x	8	1.5
RK510	24	x	8	2
RK487	12	x	10	1
RK488	15	x	10	1.25
RK489	18	x	10	1.75
RK490	24	x	10	2.25
RK491	12	x	12	1.25
RK492	15	x	12	1.75
RK493	18	x	12	2
RK494	24	x	12	2.75
RK495	12	x	14	1.5
RK496	15	x	14	2
RK497	18	x	14	2.25
RK498	24	x	14	3.25
RK499	18	x	16	2.5
RK500	18	x	18	2.75

BIN FRONTS

- Used in conjunction with bin dividers

Model No.	Dimensions			Wt. lbs.
	W"	x	H"	
RK475	36	x	1	1.75
RK477	36	x	2	2
RK479	36	x	3	2.25
RK476	42	x	1	2
RK478	42	x	2	2.25
RK480	42	x	3	2.5

LABEL HOLDERS

- Install on shelf front to identify contents of shelves

Model No.	Width"	Wt. lbs.
RK540	36	0.3
RK542	48	0.3

SHELF BOXES

- Slide onto properly spaced shelving
- Extends 100% without spills
- Constructed of 20 gauge steel

Model No.	Dimensions				Wt. lbs.	
	W"	x	D"	x		H"
RK566	5 5/8	x	12	x	2 3/4	2.5
RK569	5 5/8	x	18	x	2 3/4	3.5
RK570	5 5/8	x	12	x	4 3/4	3.5
RK572	5 5/8	x	15	x	4 3/4	4
RK573	5 5/8	x	18	x	4 3/4	4.5
RK574	11	x	18	x	4 3/4	5
RK571	12	x	12	x	4 3/4	5.5

MISCELLANEOUS

Model No.	Description	Wt. lbs.
RK949	Foot Plate	0.3
RC453	Gusset (Pairs)	1
RL756*	48" Hanger Bar	3.5
RL757	24" Hanging Bar Bracket	0.05
RC515	Shelf Clip	0.01
RC382	Back to Back Brackets	0.01
RC505	Back Panel Clip	0.2

*Requires two brackets (RL757)

SHELVING

BOLTLESS SHELVING UNITS

- Adjustable shelving system that provides high strength, yet economical storage capacity for your needs
- This system uses an innovative shelf clip, which slips into a slotted "T" post and is immediate ready to receive a shelf
- No-Bolt design reduces up to 80% of installation time
- Colour: Grey
- Ships knocked down



36" W X 6'4" H



4 SHELVES

Starter Unit	Depth"
RK205	12
RK207	18
RK209	24

Add-On Unit	Depth"
RK204	12
RK206	18
RK208	24

36" W X 6'4" H



7 SHELVES

Starter Unit	Depth"
RK217	12
RK219	18
RK221	24

Add-On Unit	Depth"
RK216	12
RK218	18
RK220	24

36" W X 6'4" H



10 SHELVES

Starter Unit	Depth"
RK229	12
RK231	18
RK233	24

Add-On Unit	Depth"
RK228	12
RK230	18
RK232	24

36" W X 6'4" H



13 SHELVES

Starter Unit	Depth"
RK241	12
RK243	18
RK245	24

Add-On Unit	Depth"
RK240	12
RK242	18
RK244	24

36" W X 7'4" H



4 SHELVES

Starter Unit	Depth"
RK309	12
RK311	18
RK313	24

Add-On Unit	Depth"
RK308	12
RK310	18
RK312	24

36" W X 7'4" H



7 SHELVES

Starter Unit	Depth"
RK333	12
RK335	18
RK337	24

Add-On Unit	Depth"
RK332	12
RK334	18
RK336	24

36" W X 7'4" H



8 SHELVES

Starter Unit	Depth"
RK321	12
RK323	18
RK325	24

Add-On Unit	Depth"
RK320	12
RK322	18
RK324	24

36" W X 7'4" H



15 SHELVES

Starter Unit	Depth"
RK345	12
RK347	18
RK349	24

Add-On Unit	Depth"
RK344	12
RK346	18
RK348	24

48" W X 7'4" H



4 SHELVES

Starter Unit	Depth"
RK285	12
RK287	18
RK289	24

Add-On Unit	Depth"
RK284	12
RK286	18
RK288	24

48" W X 7'4" H



7 SHELVES

Starter Unit	Depth"
RK297	12
RK299	18
RK301	24

Add-On Unit	Depth"
RK296	12
RK298	18
RK300	24

36" W X 8'4" H



5 SHELVES

Starter Unit	Depth"
RK425	12
RK427	18
RK429	24

Add-On Unit	Depth"
RK424	12
RK426	18
RK428	24

36" W X 8'4" H



9 SHELVES

Starter Unit	Depth"
RK401	12
RK403	18
RK405	24

Add-On Unit	Depth"
RK400	12
RK402	18
RK404	24

BOLTLESS SHELVING UNITS

- Adjustable shelving system that provides high strength, yet economical storage capacity for your needs
- This system uses an innovative shelf clip, which slips into a slotted "T" post and is immediate ready to receive a shelf
- No-Bolt design reduces up to 80% of installation time
- Colour: Grey
- Ships knocked down



36" W X 6'4" H



4 SHELVES

Starter Unit	Depth"
RK211	12
RK213	18
RK215	24

Add-On Unit	Depth"
RK210	12
RK212	18
RK214	24

36" W X 6'4" H



7 SHELVES

Starter Unit	Depth"
RK223	12
RK225	18
RK227	24

Add-On Unit	Depth"
RK222	12
RK224	18
RK226	24

36" W X 6'4" H



10 SHELVES

Starter Unit	Depth"
RK235	12
RK237	18
RK239	24

Add-On Unit	Depth"
RK234	12
RK236	18
RK238	24

36" W X 7'4" H



4 SHELVES

Starter Unit	Depth"
RK315	12
RK317	18
RK319	24

Add-On Unit	Depth"
RK314	12
RK316	18
RK318	24

36" W X 7'4" H



7 SHELVES

Starter Unit	Depth"
RK339	12
RK341	18
RK343	24

Add-On Unit	Depth"
RK338	12
RK340	18
RK342	24

36" W X 7'4" H



8 SHELVES

Starter Unit	Depth"
RK327	12
RK329	18
RK331	24

Add-On Unit	Depth"
RK326	12
RK328	18
RK330	24

36" W X 7'4" H



15 SHELVES

Starter Unit	Depth"
RK351	12
RK353	18
RK355	24

Add-On Unit	Depth"
RK350	12
RK352	18
RK354	24

48" W X 7'4" H



4 SHELVES

Starter Unit	Depth"
RK291	12
RK293	18
RK295	24

Add-On Unit	Depth"
RK290	12
RK292	18
RK294	24

48" W X 7'4" H



7 SHELVES

Starter Unit	Depth"
RK303	12
RK305	18
RK307	24

Add-On Unit	Depth"
RK302	12
RK304	18
RK306	24

36" W X 8'4" H



5 SHELVES

Starter Unit	Depth"
RK431	12
RK433	18
RK435	24

Add-On Unit	Depth"
RK430	12
RK432	18
RK434	24

36" W X 8'4" H



9 SHELVES

Starter Unit	Depth"
RK407	12
RK409	18
RK411	24

Add-On Unit	Depth"
RK406	12
RK408	18
RK410	24

36" W X 8'4" H



13 SHELVES

Starter Unit	Depth"
RK419	12
RK421	18
RK423	24

Add-On Unit	Depth"
RK418	12
RK420	18
RK422	24

SHELVING

BOLTLESS SHELVING UNITS

- Adjustable shelving system that provides high strength, yet economical storage capacity for your needs
- This system uses an innovative shelf clip, which slips into a slotted "T" post and is immediate ready to receive a shelf
- No-Bolt design reduces up to 80% of installation time
- Colour: Grey
- Ships knocked down



36" W X 6'4" H



4 SHELVES

Starter Unit	Depth"
RK849	12
RK850	18
RK851	24

Add-On Unit	Depth"
RK852	12
RK853	18
RK854	24

36" W X 7'4" H



4 SHELVES W/ DOORS

Starter Unit	Depth"
RK893	12
RK894	18
RK895	24

Add-On Unit	Depth"
RK896	12
RK897	18
RK898	24

36" W X 6'4" H



7 SHELVES W/DOORS

Starter Unit	Depth"
RK855	12
RK856	18
RK857	24

Add-On Unit	Depth"
RK858	12
RL013	18
RL015	24

36" W X 7'4" H



7 SHELVES W/DOORS

Starter Unit	Depth"
RK899	12
RK900	18
RK989	24

Add-On Unit	Depth"
RK902	12
RK903	18
RK904	24

36" W X 7'4" H



10 COMPARTMENTS W/DOORS

Starter Unit	Depth"
RK911	12
RK912	18
RK913	24

Add-On Unit	Depth"
RK914	12
RK915	18
RK916	24

36" W X 7'4" H



21 COMPARTMENTS W/DOORS

Starter Unit	Depth"
RK921	12
RK922	18
RK923	24

Add-On Unit	Depth"
RK924	12
RK925	18
RK926	24

36" W X 6'4" H



14 COMPARTMENTS

Starter Unit	Depth"
RK259	12
RK261	18
RK263	24

Add-On Unit	Depth"
RK258	12
RK260	18
RK262	24

36" W X 6'4" H



18 COMPARTMENTS

Starter Unit	Depth"
RK265	12
RK267	18
RK269	24

Add-On Unit	Depth"
RK264	12
RK266	18
RK268	24

36" W X 6'4" H



72 COMPARTMENTS W/BIN FRONTS

Starter Unit	Depth"
RK271	12
RK273	18
RK275	24

Add-On Unit	Depth"
RK270	12
RK272	18
RK274	24

36" W X 7'4" H



14 COMPARTMENTS

Starter Unit	Depth"
RK363	12
RK365	18
RK367	24

Add-On Unit	Depth"
RK362	12
RK364	18
RK366	24

36" W X 7'4" H



21 COMPARTMENTS

Starter Unit	Depth"
RK369	12
RK371	18
RK373	24

Add-On Unit	Depth"
RK368	12
RK370	18
RK372	24

36" W X 7'4" H



84 COMPARTMENTS

Starter Unit	Depth"
RK905	12
RK906	18
RK907	24

Add-On Unit	Depth"
RK908	12
RK909	18
RK910	24

BOLTLESS SHELVING UNITS

- Adjustable shelving system that provides high strength, yet economical storage capacity for your needs
- This system uses an innovative shelf clip, which slips into a slotted "T" post and is immediate ready to receive a shelf
- No-Bolt design reduces up to 80% of installation time
- Colour: Grey
- Ships knocked down



36" W X 7'4" H



84 COMPARTMENTS
W/BIN FRONTS

Starter Unit	Depth"
RK383	12
RK385	18
RK387	24

Add-On Unit	Depth"
RK382	12
RK384	18
RK386	24

36" W X 8'4" H



24 COMPARTMENTS

Starter Unit	Depth"
RK443	12
RK445	18
RK447	24

Add-On Unit	Depth"
RK442	12
RK444	18
RK446	24

36" W X 6'4" H



36 BOXES

Starter Unit	Depth"
RK277	12
RK886	18

Add-On Unit	Depth"
RK276	12
RK983	18

36" W X 6'4" H



57 BOXES

Starter Unit	Depth"
RK986	12
RK890	18

Add-On Unit	Depth"
RK891	12
RK987	18

36" W X 6'4" H



72 BOXES

Starter Unit	Depth"
RK877	12
RK878	18

Add-On Unit	Depth"
RK879	12
RK880	18

36" W X 6'4" H



108 BOXES

Starter Unit	Depth"
RK980	12
RK982	18

Add-On Unit	Depth"
RK979	12
RK981	18

36" W X 7'4" H



42 BOXES

Starter Unit	Depth"
RK935	12
RK936	18

Add-On Unit	Depth"
RK937	12
RK938	18

36" W X 7'4" H



69 BOXES

Starter Unit	Depth"
RK939	12
RK940	18

Add-On Unit	Depth"
RK941	12
RK942	18

36" W X 7'4" H



84 BOXES

Starter Unit	Depth"
RK927	12
RK928	18

Add-On Unit	Depth"
RK929	12
RK930	18

36" W X 7'4" H



126 BOXES

Starter Unit	Depth"
RK931	12
RK932	18

Add-On Unit	Depth"
RK933	12
RK934	18

36" W X 6'4" H



24 COMPARTMENTS
& 30 BOXES

Starter Unit	Depth"
RK970	12
RK868	18

Add-On Unit	Depth"
RK969	12
RK971	18

36" W X 7'4" H



27 COMPARTMENTS
& 30 BOXES

Starter Unit	Depth"
RK917	12
RK918	18

Add-On Unit	Depth"
RK919	12
RK920	18

DRAWER INSERTS

INTEGRATED SHELVING DRAWER INSERTS

FOR METALWARE SHELVING

- Integrated drawer inserts allow you to install directly into your existing or new Metalware shelving units
- The system maximizes the storage space available in your shelving unit and reduces the need for additional shelving for storage of small parts
- Drawer dividers included
- Drawer capacity: 400 lbs.
- Grey
- Other colours available upon request
- Assembly required

LISTA
making workspace work®



OVERALL HEIGHT: 24"

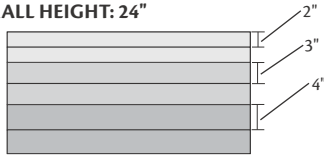

6 DRAWERS

Model No.	Dimensions			Number of Compartments
	D"	x	W"	
RL760	24	x	36	102
RL759	24	x	42	114
RL758	24	x	48	144

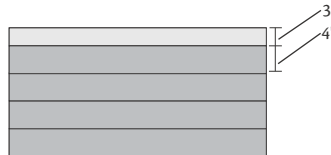

5 DRAWERS

Model No.	Dimensions			Number of Compartments
	D"	x	W"	
RL763	24	x	36	75
RL762	24	x	42	90
RL761	24	x	48	108

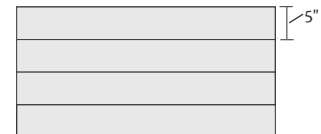

4 DRAWERS

Model No.	Dimensions			Number of Compartments
	D"	x	W"	
RL766	24	x	36	48
RL765	24	x	42	48
RL764	24	x	48	72

OVERALL HEIGHT: 36"

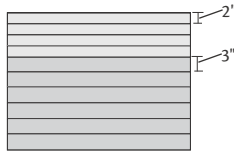

10 DRAWERS

Model No.	Dimensions			Number of Compartments
	D"	x	W"	
RL769	24	x	36	174
RL768	24	x	42	192
RL767	24	x	48	252

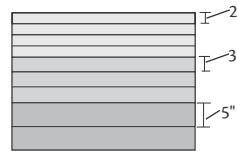

9 DRAWERS

Model No.	Dimensions			Number of Compartments
	D"	x	W"	
RL772	24	x	36	174
RL771	24	x	42	192
RL770	24	x	48	252

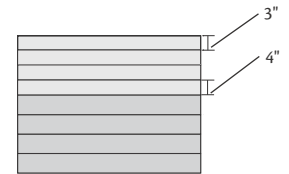

8 DRAWERS

Model No.	Dimensions			Number of Compartments
	D"	x	W"	
RL775	24	x	36	120
RL774	24	x	42	144
RL773	24	x	48	180

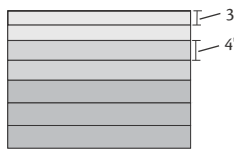

7 DRAWERS

Model No.	Dimensions			Number of Compartments
	D"	x	W"	
RL778	24	x	36	96
RL777	24	x	42	108
RL776	24	x	48	144

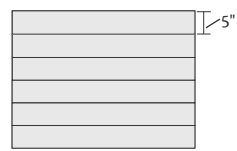

6 DRAWERS

Model No.	Dimensions			Number of Compartments
	D"	x	W"	
RL781	24	x	36	72
RL780	24	x	42	72
RL779	24	x	48	108

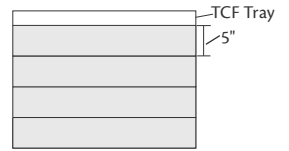

5 DRAWERS

Model No.	Dimensions			Number of Compartments
	D"	x	W"	
RL784	24	x	36	48
RL783	24	x	42	48
RL782	24	x	48	72

OVERALL HEIGHT: 48"

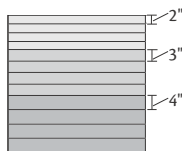

12 DRAWERS

Model No.	Dimensions			Number of Compartments
	D"	x	W"	
RL787	24	x	36	204
RL786	24	x	42	228
RL785	24	x	48	204



8 DRAWERS

Model No.	Dimensions			Number of Compartments
	D"	x	W"	
RL796	24	x	36	96
RL795	24	x	42	96
RL794	24	x	48	144

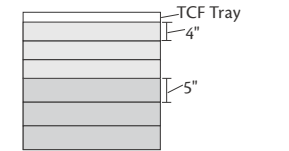

7 DRAWERS

Model No.	Dimensions			Number of Compartments
	D"	x	W"	
RL799	24	x	36	90
RL798	24	x	42	108
RL797	24	x	48	135

TCF trays are open face roll out trays

TCF trays are open face roll out trays

LABEL HOLDERS

- Clearly identify your shelf/bin contents with the efficient and time-saving Aigner holders
- Versatile, highly protective, easy to read, and even custom designed with a special matte finish, making bar code applications easy
- Ideal for all types of racking, shelving and bin/drawer storage systems
- Labels provided

HOL-DEX®

- Can be custom cut to your specific size specifications
- Package of 12

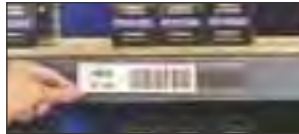

SUPERSCAN™

- Available in 4 extra large sizes for pallet-racking installation
- Clear plastic matte finish assures precise bar code reading everytime
- Inserts are laser ink jet printer compatible for easy labeling



SUPERSCAN™ (CLEAR ONLY)

Model No.	Dimensions W" x L"	Qty /Box	Model No.	Dimensions W" x L"	Qty /Box
SELF-ADHESIVE			MAGNETIC		
OG356	2 x 3 1/2	50	OG357	2 x 3 1/2	50
RG670	3 x 5	50	RG672	3 x 5	50
RG671	4 x 6	50	RG673	4 x 6	50
RG681	5 x 7	25	RG683	5 x 7	25

WIRE-RAC™

- Snap-on holders easily and quickly identify stored contents
- Clear, flexible plastic sleeves fit new or existing wire shelving with 1 1/4" facing; paper inserts included

Model No.	Dimensions W" x L"	Qty /Box
RH683	1 5/16 x 3	25
RH684	1 5/16 x 6	25
RH685	1 5/16 x 12	12
RH686	1 5/16 x 24	6



SLIP 'N STIK™ AISLE SIGNS

- Create your own customized warehouse signs
- Built-in flexible hinge prevents breakage
- Includes:** 10 sign holders (11" x 8 1/2"), 12 yellow laser/ink jet sheets and instructions

Model No. OE798 Snap-On

- Snaps into pallet rack assembly holes, can snap out to relocate

Model No. OJ943 Self-Adhesive

- Adheres to flat surfaces, for more permanent applications



WRITE-ON MAGNETIC TAGS

- A fast, simple and inexpensive means of labeling high-volume applications, primary uses in warehouses and other storage areas
- Newly formulated write-on/wet erase tags come with a strong magnetic backing
- Special wet-erase feature will keep tags clear and clean for extended periods
- Mark with a standard wet erase marker, erase with a damp cloth and remark

50' ROLLS

Model No.	Width"
RH698	1
RH699	2
RH700	3

TAGS, 25/BOX

Model No.	Dimensions W" x L"
RH696	3 x 6
RH697	3 x 8
RH693	2 x 6



MAGNETIC TAPE FOR LABELS

- Peel and stick computer printed or hand written labels to non magnetic (matte) side
- Scissor cut to desired length
- Magnetic (shiny) side adheres to metal surface
- Can change label or relocate as required

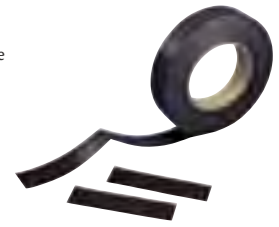

Model No.	Dimensions W" x L"
OJ940	1 x 50
OJ941	2 x 50
OJ942	3 x 50

Custom pre-scored sizes available

SLIP STRIP™ LABEL HOLDING SYSTEMS

- Excellent for displaying bar codes, messages, prices or other information on pallet racking and shelving
- Self-adhesive label/document holder system allows you to change labels without messy adhesive build-up
- 6 per package

Model No.	Dimensions W" x L"
OE802	1 x 36
OE803	1 1/4 x 48
OE804	2 x 48



MAGNETIC CARD HOLDERS

- Fast, simple and versatile means of labeling
- Great for metal racks, shelves, bins, drawers and more
- Insertable magnetic C-channel design allows for labels to be changed simply by re-marking the paper insert or re-positioning the magnet
- Black
- Custom cut sizes available on special order
- Inserts included

Model No.	Dimensions W" x L"	Qty /Box
OE250	1 x 3	25
OE251	1 x 4	25
OE252	1 x 6	25
OE253	1 x 8	25
OE254	2 x 3	25
OE255	2 x 4	25
OE256	2 x 6	25
OE257	2 x 8	25
OE258	3 x 4	25
OE259	3 x 6	25
OE260	3 x 8	25



PREMIUM JOB TICKET HOLDERS

- Protect work orders, production schedules, inventory cards and other important documents from excessive handling and wear
- Sewn edges are reinforced with heavy-duty vinyl and a brass eyelet is centered for hanging
- Clear 8 mil. PVC for easy visibility

Model No.	Dimensions W" x L"	Qty /Box
PC529	9 x 6	25
PC530	12 x 9	25



OPEN-EDGE™ LABEL HOLDERS

- The "top loading" feature is ideal for organizing any storage area
- Strong adhesive system assures the label holder will not fall off any clean dry surface
- Made from clear, durable, heavy-duty PVC that is bar code compatible
- White inserts included

Model No.	Dimensions W" x L"	Qty /Box
OG358	1/2 x 12	100
OG359	1 x 12	100
OG360	2 x 12	100
OG361	3 x 5	100

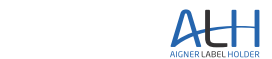

SHELVING & RACKING

STAINLESS STEEL SOLID RIVET SHELVING

- High quality stainless steel solid shelving made of type 304 stainless steel construction with brushed finish
- 18-gauge thick shelves adjustable in 1 1/2" increments
- Two-piece corner posts design includes plastic connectors
- **Includes:** Five adjustable shelves with a capacity of 600 lbs. per shelf
- Shipped knocked down, easy assembly



Model No.	Dimensions				Cap lbs. /Shelf
	W"	x D"	x H"		
RL853	18	x 36	x 72		600
RL854	18	x 48	x 72		600
RL855	24	x 36	x 72		600
RL856	24	x 48	x 72		600

ULTRARACK HEAVY-DUTY BOLTLESS SHELVING

- Modular design; use as storage shelving, a work centre or assemble as a workbench
- Heavy-duty 16-gauge steel construction provides maximum weight carrying capacity
- Each shelf supports 600 - 1800 lbs. based on evenly distributed loads
- Double riveted beams lock into heavy-duty corner post to form a structurally secure unit
- Includes five particleboard shelves that adjust easily on 1 1/2" centres
- Convenient access from all four sides
- Tough baked enamel finish



Model No.	Dimensions				Cap/Shelf lbs.
	W"	x D"	x H"		
RL894	36	x 18	x 72		1200
RL895	36	x 24	x 72		1800
RL896	48	x 18	x 72		1000
RL897	48	x 24	x 72		1400

HEAVY-DUTY BULK STORAGE RACKS

- These racks bridge the gap between pallet racking and conventional industrial racking
- Engineered for hand loading of intermediate weight bulky items
- Constructed of all welded 14-gauge steel upright frames punched on 1 1/2" centres
- 14-gauge Z-step beam design provides maximum weight capacity
- Comes with 5/8" thick particle board decking (steel decking also available)
- Additional shelves include two beams and a deck
- Other dimensions also available
- Assembly required

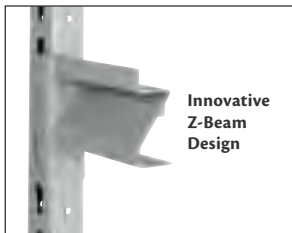

Innovative Z-Beam Design

Starter Model No.	Wt. lbs.	Add-on Model No.	Wt. lbs.	Rack Height'	Rack Width"	Cap. lbs. /Shelf
STANDARD 3 SHELF UNITS - 24" DEEP UNIT						
RK028	181	RK046	158	6	60	4000
RK029	205	RK047	182		72	3500
RK030	253	RK048	230		96	2800
RK031	199	RK049	167	8	60	4000
RK032	223	RK050	191		72	3500
RK033	271	RK051	239		96	2800

STANDARD 3 SHELF UNITS - 36" DEEP UNIT						
RK040	221	RK052	196	6	60	4000
RK041	254	RK053	229		72	3500
RK042	317	RK054	292		96	2800
RK043	243	RK055	207	8	60	4000
RK044	276	RK056	240		72	3500
RK045	339	RK057	303		96	2800

ADDITIONAL SHELVES

24" Deep unit	Wt. lbs.	36" Deep unit	Wt. lbs.	Rack Width"
RK058	45	RK061	57	60
RK059	53	RK062	68	72
RK060	69	RK063	89	96

EXTRA HEAVY-DUTY SHELVING

DESIGNED TO HOLD THE HEAVIEST LOADS

- Clear access on all four sides
- Excellent for storage of dies, fixtures, jigs or any heavy material
- Formed angle 2" x 2" uprights are constructed of 13-gauge steel, punched on 1" centres for quick and easy shelf adjustment
- Powder coat finish
- Shelf capacities are based on loads that are evenly distributed
- Extra shelves and 96" high units are available
- Each unit includes five shelves
- Assembly required

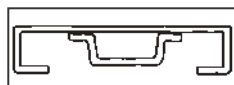

Shelves:

14-gauge, 2" deep channels on all four sides.

An extra channel welded to the bottom of shelf to prevent flexing under heavy loads.



Model No.	Dimensions				Cap lbs. /Shelf	Wt. lbs.
	W"	x D"	x H"			
RC524	36	x 18	x 72		3000	167
RC525	48	x 18	x 72		3000	212
RC526	60	x 18	x 72		3000	252
RC527	36	x 24	x 72		3000	197
RC528	48	x 24	x 72		3000	242
RC529	60	x 24	x 72		3000	292

PRONTO BULK STORAGE RACKS

- Up to 2000-lb. capacity per shelf
- Starter unit includes two all-welded end frames, and three 5/8" presswood shelves flush-fitted into positive locking steel shelf beams (two per shelf)
- Add-on units include only one end frame
- Additional shelves may be added into any unit at 4" vertical centres
- For extra stability and rigidity, all units feature three safety bars per shelf
- Blue enamel finish
- Rack only units (no wood shelves) are available upon inquiry

Note: Not recommended for powered lift truck applications.

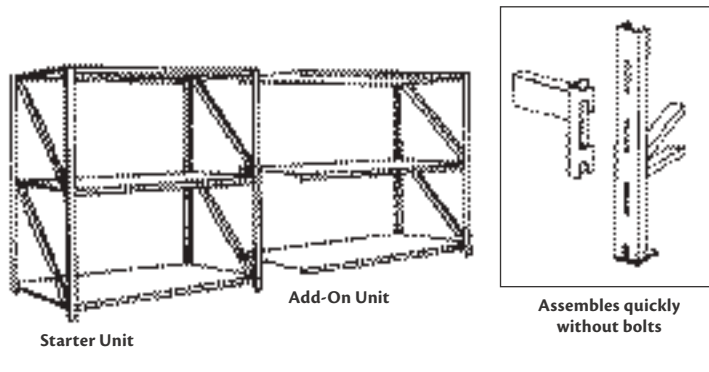

24" SHELF DEPTH				36" SHELF DEPTH			48" SHELF DEPTH	
Dim. W' x H'	Description	Cap. lbs.	Model No.	Wt. lbs.	Model No.	Wt. lbs.	Model No.	Wt. lbs.
7 x 8	Starter	1400	RA443	245	RA475	288	RA507	331
7 x 8	Add-on	1400	RA441	217	RA473	258	RA505	299
7 W	Add'l shelf	1400	RA470	63	RA502	76	RA534	89
8 x 10	Starter	2000	RA453	302	RA485	351	RA517	400
8 x 10	Add-on	2000	RA451	268	RA483	315	RA515	362
8 W	Add'l shelf	2000	RA471	78	RA503	93	RA535	108
8 x 12	Starter	2000	RA463	316	RA495	365	RA527	414
8 x 12	Add-on	2000	RA461	275	RA493	322	RA525	369
8 W	Add'l shelf	2000	RA471	78	RA503	93	RA535	108

BULK STORAGE RACKS

- Ideal solution for storage of large and bulky items
- Designed to work without nuts and bolts which allows for assembly in minutes
- Shelves are adjustable among 1 1/2" increments
- Optional particle board deck panels combine economy and strength and are easy to install
- Units come standard with sturdy 84" high, 14-gauge posts and left to right beams as well as 16-gauge front to back beams
- Double riveted beams lock into corner posts to eliminate back and side sway
- Durable baked gray enamel finish to resist rust and corrosion
- Shipped knocked down



Dimensions					Shelf Cap. lbs.	3 Levels		4 Levels		Particle Board Deck	
W"	x	D"	x	H"		Model No.	Wt. lbs.	Model No.	Wt. lbs.	Model No.	Wt. lbs.
48	x	24	x	84	1200	RL124	62	RL139	74	RL154	20
48	x	36	x	84	1200	RL125	68	RL140	82	RL155	29
48	x	48	x	84	1200	RL126	74	RL141	90	RL156	39
60	x	24	x	84	1000	RL127	72	RL142	88	RK016	25
60	x	36	x	84	1000	RL128	78	RL143	96	RK019	37
60	x	48	x	84	1000	RL129	84	RL144	104	RL157	49
72	x	24	x	84	750	RL130	74	RL145	90	RK017	29
72	x	36	x	84	750	RL131	80	RL146	98	RK020	44
72	x	48	x	84	750	RL132	86	RL147	106	RL158	59
96	x	24	x	84	600	RL133	86	RL148	106	RK018	39
96	x	36	x	84	600	RL134	92	RL149	114	RK021	59
96	x	48	x	84	600	RL135	98	RL150	122	RL159	78
96	x	24	x	84	800	RL136	98	RL151	122	RK018	39
96	x	36	x	84	800	RL137	104	RL152	130	RK021	59
96	x	48	x	84	800	RL138	110	RL153	138	RL159	78



RACKING

UPRIGHTS & STRINGERS

Make every inch of your storage space count by combining standard sized uprights and stringers (box type or recessed type) to create a racking system that is customized to your needs.

- Feature a 50 k.s.i. minimum yield to achieve higher load capacities
- Various racking accessories (below) may be added to store any specialty items that regular racking cannot handle
- **All racking is FOB Concord, Ontario**

Contact our sales department for further technical assistance.



MEDIUM DUTY UPRIGHTS 20000-LB. CAPACITY

Depth	24"	30"	36"	42"	48"	60"
6'	RB798	RB800	RB802	RB803	RB804	RB805
7'	RB806	RB808	RB810	RB811	RB812	RB813
8'	RB814	RB816	RB818	RB819	RB820	RB821
9'	RB822	RB824	RB826	RB827	RB828	RB829
10'	RB742	RB744	RB746	RB747	RB748	RB749
11'	RB750	RB752	RB754	RB755	RB756	RB757
12'	RB758	RB760	RB762	RB763	RB764	RB765
13'	RB766	RB768	RB770	RB771	RB772	RB773
14'	RB774	RB776	RB778	RB779	RB780	RB781
15'	RB782	RB784	RB786	RB787	RB788	RB789
16'	RB790	RB792	RB794	RB795	RB796	RB797

HEAVY-DUTY UPRIGHTS 27000-LB. CAPACITY

Depth	24"	30"	36"	42"	48"	60"
6'	RB714	RB715	RB716	RB717	RB718	RB719
7'	RB720	RB721	RB722	RB723	RB724	RB725
8'	RB726	RB728	RB730	RB731	RB732	RB733
9'	RB734	RB736	RB738	RB739	RB740	RB741
10'	RB608	RB610	RB612	RB613	RB614	RB615
11'	RB616	RB618	RB620	RB621	RB622	RB623
12'	RB624	RB626	RB628	RB629	RB630	RB631
13'	RB632	RB634	RB636	RB637	RB638	RB639
14'	RB640	RB642	RB644	RB645	RB646	RB647
15'	RB648	RB650	RB652	RB653	RB654	RB655
16'	RB656	RB658	RB660	RB661	RB662	RB663
18'	RB664	RB666	RB668	RB669	RB670	RB671
20'	RB672	RB674	RB676	RB677	RB678	RB679
22'	RB680	RB682	RB684	RB685	RB686	RB687
24'	RB688	RB690	RB692	RB693	RB694	RB695
26'	RB696	RB697	RB698	RB699	RB700	RB701
28'	RB702	RB703	RB704	RB705	RB706	RB707
30'	RB708	RB709	RB710	RB711	RB712	RB713

Box Type Stringer



Recessed Type Stringer



BOX TYPE STRINGERS CAP. LBS. PER PAIR

LGTH	48"	54"	60"	66"	72"	78"	84"	90"	96"	102"	108"	114"	120"	126"	132"	138"	144"																																																																																																																																																																																																																																																																																																																																																																																																																																																																																																																																																																																																																																																																																																																																																																																																																																																																																																																																																																																																																																																																																																																																																																																																																																															
2"	RB203	5340	RB204	4385	RB205	3551	RB206	2936	RB207	2466	RB208	2101	RB209	1578	RB210	1812	RB211	1388	RB212	1229	RB213	1876	RB214	1684	RB215	1520	RB216	1378	RB217	1255	RB218	1149	RB219	1055	RB220	939	RB221	8350	RB222	6078	RB223	5024	RB224	4221	RB225	3596	RB226	3102	RB227	2702	RB228	2374	RB229	2103	RB230	1876	RB231	1684	RB232	1520	RB233	1378	RB234	1255	RB235	1149	RB236	1055	RB237	939	RB238	8350	RB239	7518	RB240	6839	RB241	6265	RB242	5630	RB243	4855	RB244	4229	RB245	3716	RB246	3293	RB247	2937	RB248	2636	RB249	2379	RB250	2158	RB251	1966	RB252	1799	RB253	1650	RB254	1503	RB255	1359	RB256	1220	RB257	1086	RB258	958	RB259	835	RB260	716	RB261	602	RB262	493	RB263	389	RB264	290	RB265	196	RB266	107	RB267	21	RB268	1	RB269	1	RB270	1	RB271	1	RB272	1	RB273	1	RB274	1	RB275	1	RB276	1	RB277	1	RB278	1	RB279	1	RB280	1	RB281	1	RB282	1	RB283	1	RB284	1	RB285	1	RB286	1	RB287	1	RB288	1	RB289	1	RB290	1	RB291	1	RB292	1	RB293	1	RB294	1	RB295	1	RB296	1	RB297	1	RB298	1	RB299	1	RB300	1	RB301	1	RB302	1	RB303	1	RB304	1	RB305	1	RB306	1	RB307	1	RB308	1	RB309	1	RB310	1	RB311	1	RB312	1	RB313	1	RB314	1	RB315	1	RB316	1	RB317	1	RB318	1	RB319	1	RB320	1	RB321	1	RB322	1	RB323	1	RB324	1	RB325	1	RB326	1	RB327	1	RB328	1	RB329	1	RB330	1	RB331	1	RB332	1	RB333	1	RB334	1	RB335	1	RB336	1	RB337	1	RB338	1	RB339	1	RB340	1	RB341	1	RB342	1	RB343	1	RB344	1	RB345	1	RB346	1	RB347	1	RB348	1	RB349	1	RB350	1	RB351	1	RB352	1	RB353	1	RB354	1	RB355	1	RB356	1	RB357	1	RB358	1	RB359	1	RB360	1	RB361	1	RB362	1	RB363	1	RB364	1	RB365	1	RB366	1	RB367	1	RB368	1	RB369	1	RB370	1	RB371	1	RB372	1	RB373	1	RB374	1	RB375	1	RB376	1	RB377	1	RB378	1	RB379	1	RB380	1	RB381	1	RB382	1	RB383	1	RB384	1	RB385	1	RB386	1	RB387	1	RB388	1	RB389	1	RB390	1	RB391	1	RB392	1	RB393	1	RB394	1	RB395	1	RB396	1	RB397	1	RB398	1	RB399	1	RB400	1	RB401	1	RB402	1	RB403	1	RB404	1	RB405	1	RB406	1	RB407	1	RB408	1	RB409	1	RB410	1	RB411	1	RB412	1	RB413	1	RB414	1	RB415	1	RB416	1	RB417	1	RB418	1	RB419	1	RB420	1	RB421	1	RB422	1	RB423	1	RB424	1	RB425	1	RB426	1	RB427	1	RB428	1	RB429	1	RB430	1	RB431	1	RB432	1	RB433	1	RB434	1	RB435	1	RB436	1	RB437	1	RB438	1	RB439	1	RB440	1	RB441	1	RB442	1	RB443	1	RB444	1	RB445	1	RB446	1	RB447	1	RB448	1	RB449	1	RB450	1	RB451	1	RB452	1	RB453	1	RB454	1	RB455	1	RB456	1	RB457	1	RB458	1	RB459	1	RB460	1	RB461	1	RB462	1	RB463	1	RB464	1	RB465	1	RB466	1	RB467	1	RB468	1	RB469	1	RB470	1	RB471	1	RB472	1	RB473	1	RB474	1	RB475	1	RB476	1	RB477	1	RB478	1	RB479	1	RB480	1	RB481	1	RB482	1	RB483	1	RB484	1	RB485	1	RB486	1	RB487	1	RB488	1	RB489	1	RB490	1	RB491	1	RB492	1	RB493	1	RB494	1	RB495	1	RB496	1	RB497	1	RB498	1	RB499	1	RB500	1	RB501	1	RB502	1	RB503	1	RB504	1	RB505	1	RB506	1	RB507	1	RB508	1	RB509	1	RB510	1	RB511	1	RB512	1	RB513	1	RB514	1	RB515	1	RB516	1	RB517	1	RB518	1	RB519	1	RB520	1	RB521	1	RB522	1	RB523	1	RB524	1	RB525	1	RB526	1	RB527	1	RB528	1	RB529	1	RB530	1	RB531	1	RB532	1	RB533	1	RB534	1	RB535	1	RB536	1	RB537	1	RB538	1	RB539	1	RB540	1	RB541	1	RB542	1	RB543	1	RB544	1	RB545	1	RB546	1	RB547	1	RB548	1	RB549	1	RB550	1	RB551	1	RB552	1	RB553	1	RB554	1	RB555	1	RB556	1	RB557	1	RB558	1	RB559	1	RB560	1	RB561	1	RB562	1	RB563	1	RB564	1	RB565	1	RB566	1	RB567	1	RB568	1	RB569	1	RB570	1	RB571	1	RB572	1	RB573	1	RB574	1	RB575	1	RB576	1	RB577	1	RB578	1	RB579	1	RB580	1	RB581	1	RB582	1	RB583	1	RB584	1	RB585	1	RB586	1	RB587	1	RB588	1	RB589	1	RB590	1	RB591	1	RB592	1	RB593	1	RB594	1	RB595	1	RB596	1	RB597	1	RB598	1	RB599	1	RB600	1	RB601	1	RB602	1	RB603	1	RB604	1	RB605	1	RB606	1	RB607	1	RB608	1	RB609	1	RB610	1	RB611	1	RB612	1	RB613	1	RB614	1	RB615	1	RB616	1	RB617	1	RB618	1	RB619	1	RB620	1	RB621	1	RB622	1	RB623	1	RB624	1	RB625	1	RB626	1	RB627	1	RB628	1	RB629	1	RB630	1	RB631	1	RB632	1	RB633	1	RB634	1	RB635	1	RB636	1	RB637	1	RB638	1	RB639	1	RB640	1	RB641	1	RB642	1	RB643	1	RB644	1	RB645	1	RB646	1	RB647	1	RB648	1	RB649	1	RB650	1	RB651	1	RB652	1	RB653	1	RB654	1	RB655	1	RB656	1	RB657	1	RB658	1	RB659	1	RB660	1	RB661	1	RB662	1	RB663	1	RB664	1	RB665	1	RB666	1	RB667	1	RB668	1	RB669	1	RB670	1	RB671	1	RB672	1	RB673	1	RB674	1	RB675	1	RB676	1	RB677	1	RB678	1	RB679	1	RB680	1	RB681	1	RB682	1	RB683	1	RB684	1	RB685	1	RB686	1	RB687	1	RB688	1	RB689	1	RB690	1	RB691	1	RB692	1	RB693	1	RB694	1	RB695	1	RB696	1	RB697	1	RB698	1	RB699	1	RB700	1	RB701	1	RB702	1	RB703	1	RB704	1	RB705	1	RB706	1	RB707	1	RB708	1	RB709	1	RB710	1	RB711	1	RB712	1	RB713	1	RB714	1	RB715	1	RB716	1	RB717	1	RB718	1	RB719	1	RB720	1	RB721	1	RB722	1	RB723	1	RB724	1	RB725	1	RB726	1	RB727	1	RB728	1	RB729	1	RB730	1	RB731	1	RB732	1	RB733	1	RB734	1	RB735	1	RB736	1	RB737	1	RB738	1	RB739	1	RB740	1	RB741	1	RB742	1	RB743	1	RB744	1	RB745	1	RB746	1	RB747	1	RB748	1	RB749	1	RB750	1	RB751	1	RB752	1	RB753	1	RB754	1	RB755	1	RB756	1	RB757	1	RB758	1	RB759	1	RB760	1	RB761	1	RB762	1	RB763	1	RB764	1	RB765	1	RB766	1	RB767	1	RB768	1	RB769	1	RB770	1	RB771	1	RB772	1	RB773	1	RB774	1	RB775	1	RB776	1	RB777	1	RB778	1	RB779	1	RB780	1	RB781	1	RB782	1	RB783	1	RB784	1	RB785	1	RB786	1	RB787	1	RB788	1	RB789	1	RB790	1	RB791	1	RB792	1	RB793	1	RB794	1	RB795	1	RB796	1	RB797	1	RB798	1	RB799	1	RB800	1	RB801	1	RB802	1	RB803	1	RB804	1	RB805	1	RB806	1	RB807	1	RB808	1	RB809	1	RB810	1

CENTENNIAL PROFILE ACCESSORIES

FLUSH SAFETY BARS FOR BOX BEAMS

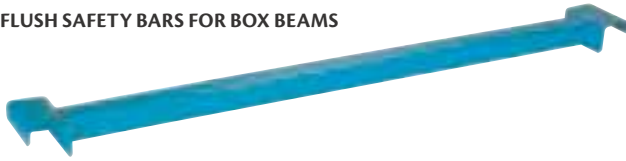

Model No.	Dimensions			Wt. Cap. lbs.
	W"	x	L"	
RB878	2	x	42	1100
RB884	6	x	42	1200
RB872	12	x	42	1200

DRUM CRADLES

- For positive positioning of cylindrical containers
- Unit fits onto cross bars and provides wedge type security



Model No.	Description
RB847	Drum Cradle (Type II - 36")
RB848	Drum Cradle (Type II - 42")

SKID CHANNELS

- For use with legged skids
- Fits across beams, from front to rear
- Recessed channel provides support for skid legs

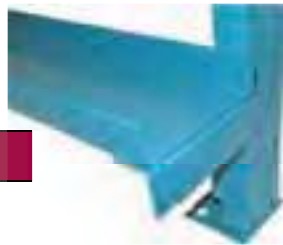

Model No.	Dimensions		
	W"	x	L"
RB920	6	x	24
RB921	6	x	30
RB922	6	x	36
RB923	6	x	42
RB924	6	x	48
RB918	12	x	42

WALL CONNECTORS

- Wall connectors are used to provide a tie between racking and the wall
- Plate is punched to allow lagging



Model No.	Dimensions"
RB835	6
RB830	12

ROW CONNECTORS

- Row connectors are used on back to back racking layouts to maintain spacing between rows
- May be located at any level other than where a stringer is located



Model No.	Dimensions"
RB327	6
RB328	8
RB322	12

WIRE DECKING

- Easy to install
- Step/Waterfall style
- Three channels sit on the beam to carry the load
- Capacity: 2500 lbs.
- Grey

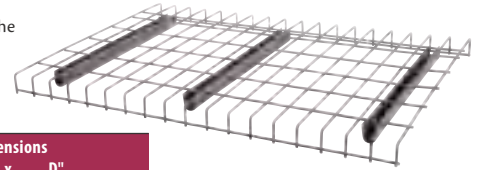

Model No.	Dimensions		
	W"	x	D"
RL379	46	x	42
RL380	52	x	42
RL377	46	x	36
RL378	52	x	36

PALLET RACK BACK GUARDS

Back guards help prevent accidents by keeping pallets and their contents from falling off the back of the rack. These guards increase safety where pedestrian pathways are behind the rack.

- Constructed using a 10-gauge frame, and 2" x 2", 10-gauge wire mesh with stiffeners
- Available in a variety of sizes to fit most pallet rack configurations
- Guard brackets are designed to fit almost any style of rack
- Durable safety yellow finish
- Hardware not included

KH131



ML231



Create a pallet rack back guard designed for your application

1. Choose one or a combination of back guard panels to create the required width and length

Model No.	Dimensions'	Weight lbs.
KH926	1 x 4	10
KH914	2 x 4	12
KH930	3 x 4	20
KD130	4 x 4	23
KD131	8 x 4	45

2. Choose a mounting bracket that provides the required depth
 - Minimum of four brackets required

Model No.	Dimensions"	Weight lbs.
ML231	4 x 6	2
ML232	4 x 9	2
ML233	4 x 12	3

3. Hardware required

- For each additional panel, add: 2 x MMB721 and 2 x MMH254
- For each mounting bracket, add: 3 x MMP624 and 3 x MMB721

For our complete line of labels & label holders



See page B37

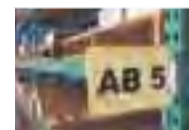

STORAGE RACKS

BAR STORAGE RACKS

All-steel vertical and horizontal racks are ideal for storing bars, tubes, pipes and angles. Economical knocked-down design reduces storage and shipping costs.

COMBINATION VERTICAL RACKS

- Stores bars up to 12' long and features three shelves for extra storage of small parts
- 8" deep arms divided into three sections
- Overall dimensions: 36" W x 24" D x 84" H
- Capacity: 3000 lbs.
- Durable Kleton blue enamel finish
- Weight: 128 lbs.

Model No. RL922

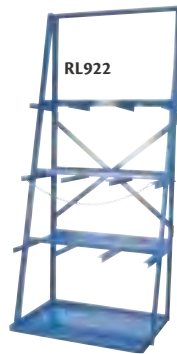

HORIZONTAL BAR RACKS

- Stores bars up to 10' long
- 9" deep arms with nine storage levels at 6" intervals
- Overall dimensions: 18" W x 40" D x 84" H
- Capacity: 1200 lbs.
- Durable Kleton blue enamel finish
- Weight: 68 lbs.

Model No. RB958

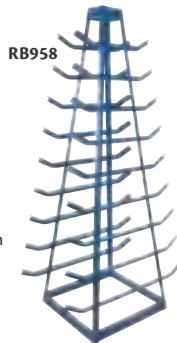

VERTICAL BAR RACKS

- All-welded steel construction
- Vertically stores bars up to 10' long
- Four 24" deep dividers
- Overall dimensions: 48" W x 24" D x 60" H
- Capacity: 3000 lbs.
- Durable Kleton blue enamel finish
- Weight: 100 lbs.

Model No. RL383

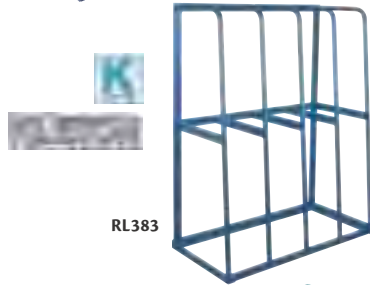

MOBILE PIPE & BAR RACKS

- Safely stores up to 1000 lbs. of material
- Folds to compact size of 61" W x 34" D x 15 1/2" H
- Features four rack levels with curved edges to prevent pipe from rolling off
- Constructed of structural square tubing
- Two swivel and two rigid, 6" hard rubber casters
- Overall dimensions: 58 1/2" W x 34" D x 58" H
- Blue enamel finish
- Weight: 100 lbs.

Model No. RB951

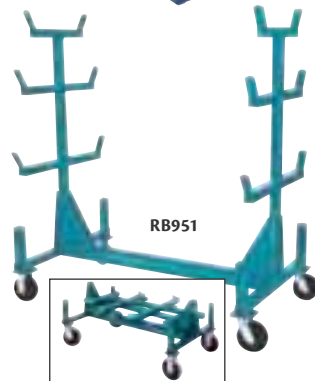

STANDARD VERTICAL SHEET RACKS

- All-welded steel construction
- Designed for vertically storing sheet goods
- Constructed of heavy gauge steel 1 1/4" tube for bays and a heavy gauge steel 1" x 2" rectangular tube for the frame
- Each bay can hold up to 1000 lbs.
- Capacity: 4000 lbs.
- Durable Kleton blue enamel finish

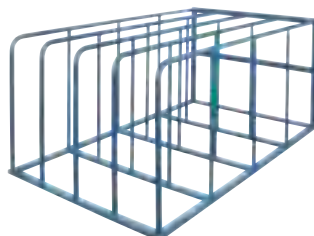

Model No.	Overall Dim. W" x D" x H"	Number of Bays	Distance Between Bays"	Wt. lbs.
RL384	84 x 50 x 36	4	10	200

CANTILEVER BAR-STOCK RACKING

LIGHT-DUTY

- All-welded components assemble easily
- Seven 12" adjustable arms per column side
- Capacity per arm: 1000 lbs.
- 36" W x 18 1/4" D x 75" H
- Shipped knocked down

REGULAR-DUTY

- Ideal for storing of steel, iron, aluminum, wood or plastic pipe
- All-welded components assemble easily
- Seven 14" adjustable arms per column side
- Capacity per arm: 2000 lbs.
- 36" W or 72" W x 21" D x 84" H
- Shipped knocked down



LIGHT-DUTY

Model No.	Description	Capacity lbs. /Unit	Wt. lbs.
RL730	Single-Sided	7000	306
RL731	Double-Sided	14000	434

REGULAR-DUTY

Model No.	Description	Width"	Capacity lbs. /Unit	Wt. lbs.
STARTER				
RL732	Single-Sided	36	14 000	315
RL734	Double-Sided	36	28 000	452
RL736	Single-Sided	72	14 000	329
RL738	Double-Sided	72	28 000	466
ADD-ON				
RL733	Single-Sided	36	7000	168
RL735	Double-Sided	36	14 000	236
RL737	Single-Sided	72	7000	182
RL739	Double-Sided	72	14 000	250

For capacities to be validated, units must be anchored to slab using a minimum of two 1/2" x 3 3/4" wedge anchors per column (MLA725)

THREADED ROD RACKS

- Eighteen 2 1/8" diameter openings
- Overall dimensions: 24 1/8" W x 6 7/8" D x 24" H
- Weight: 16 lbs.
- Grey
- Shipped knocked down

Model No. CB578



DURHAM MFG
Est. 1922

HORIZONTAL SHEET RACKS

- Designed for storage of sheet materials
- Flat storage fully supports materials and reduces warping
- Sheets are accessible from all four sides
- All-welded construction and the frame is made of 2" square tubing
- Five shelf design creates four storage bays spaced 9 1/2" apart and an open top bay
- Bay Capacity: 2000 lbs. evenly distributed
- Maximum rack capacity: 8000 lbs.



Model No.	Overall Dim. L" x W" x H"	Number of Shelves	Net Wt. lbs.
RL923	103 x 55 x 48	5	575

NESTABLE EXPORT PALLETS

- Economic, environmental and efficient alternative to wood pallets
- 100% recyclable export pallet made from 100% recycled material
- Low cost lightweight pallet ideal for export and 1-way shipments
- Available in a flat deck **CC435** or discontinuous rim to reduce load shifting **CC436**
- Flow thru design allows for easy cleaning
- True 4-way entry for forklifts and pallet trucks
- ISPM 15 exempt



ORBIS

Model No.	Dimensions			Capacity lbs.		Wt. lbs.
	L" x W" x H"	Static	Dynamic			
CC435	48 x 40 x 5 1/2	10000	2300	21.5		
CC436	48 x 40 x 6 1/2	10000	2300	21.5		

LIGHT DUTY EXPORT PALLETS

- Low cost lightweight alternative to wood pallets.
- Made of 100% recycled plastics and completely recyclable
- These low cost, single use pallets are designed for export oriented companies
- Pallets are nestable for easy storing and space saving
- 4-way entry for both forklift and pallet truck
- Streamlines customs process and reduces shipping delays
- ISPM 15 exempt

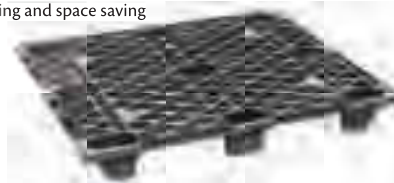

Model No.	Dimensions			Capacity lbs.		Wt. lbs.
	L" x W" x H"	Static	Dynamic			
MN457	48 x 40 x 5.2	3500	1500	12.5		

RACKSTAR II PALLETS

- Highly impact resistant design
- 100% recyclable with fully removable reinforcement structure
- Solid wall design for increased durability
- 4-way forklift accessible
- Easy to sanitize
- Removable/repairable stringers or full frame bottom, with easy-to-replace fasteners, are available for added capacity in forklift and conveyor use
- Rackable
- ISPM 15 exempt



ORBIS

Model No.	Description	Dim. L" x W"	Capacity lbs.		Capacity lbs. Centre Edge			Wt. lbs.
			Static	Dynamic	Decking	Supports	Supported	
CC163	w/o Lip (Includes 16 Deck Grommets)	48 x 40	30000	6000	6000	6000	3000	56.6

MEDIUM-DUTY RACKABLE PLASTIC PALLETS

- Unique rib design for easy cleaning and sanitary applications
- Edge-supported racking application, maximum capacity of 1400 lbs.
- Bottom design of pallet ideal for automated conveying
- Anti-skid grommets on both top and bottom
- High pressure injection molded plastic pallets made with recyclable materials
- Grey
- ISPM 15 exempt

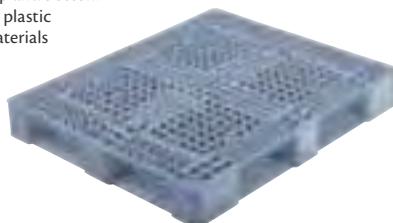

MONOFLO
INTERNATIONAL, INC.

Model No.	Dimensions			Capacity lbs.		Wt. lbs.
	L" x W" x H"	Static	Dynamic			
MN172	48 x 40 x 6	30000	3000	42		

REUSABLE NESTABLE PALLETS

- Nestable pallet designed for long life
- Choice of two popular small footprint pallets
- 100% recyclable and reusable pallet with long service life
- Economic, environmental and efficient alternative to wood pallets
- 2-way entry for forklift and hand pallet trucks
- ISPM 15 exempt



ORBIS

Model No.	Dimensions			Capacity lbs.		Wt. lbs.
	L" x W" x H"	Static	Dynamic			
CB518	28 x 20 x 5.3	5000	1500	9.4		
CB519	40 x 28 x 5.3	10000	2000	18.9		

NESTABLE SINGLE-FACED PALLETS

- 1-piece structural foam pallets are lightweight, nestable and recyclable
- High-density polyethylene construction
- Large rectangular legs make it an excellent choice for most conveyor systems
- Fork lift: 4-ways
- Pallet truck: 4-ways
- ISPM 15 exempt

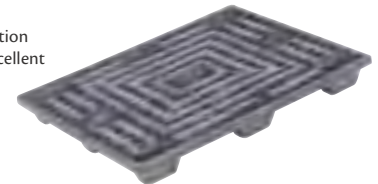

ORBIS

Model No.	Dimensions			Capacity lbs.		Wt. lbs.
	L" x W" x H"	Static	Dynamic			
CB520	48 x 40 x 5	30000	3000	29		
CB524	48 x 48 x 5 3/4	30000	4000	45.5		

RACKSTAR PALLETS

- Ideal for use in food industry and in situations where higher capacity racking capabilities are important
- Double-deck, 1-piece construction with an open grid and large corner for easy cleaning
- Standard high-density polyethylene or USDA/ FDA approved HDPE
- In an edge-supported rack, pallet can hold up to a 2500 lbs. evenly distributed load
- Dynamic load capacity of 5000 lbs.
- Static load capacity: 30000 lbs.
- 4-way fork lift or pallet truck entry
- Colour: Standard-Black, USDA/FDA-Blue
- ISPM 15 exempt



ORBIS

Model No.	Description	Dimensions"			Wt. lbs.
		L" x W" x H"			
CB536	Standard	48 x 40 x 6 5/8	45		
CB537	USDA/FDA Food Approved	48 x 40 x 6 5/8	45		

Note: Test for pallet deflection on loads over 2500 lbs. when used with unsupported (edge-supported) pallet rack.

MEDIUM-DUTY FOOD GRADE PALLETS

- Typically used in the food industry
- 1-piece construction with an open grid for easy cleaning
- Made of FDA compliant HDPE virgin material for direct food contact
- Edge-supported pallet on a rack can hold up to a 2200-lb evenly distributed load
- 4-way fork lift or pallet truck entry
- ISPM 15 exempt



Model No.	Dimensions			Capacity lbs.		Wt. lbs.
	L" x W" x H"	Static	Dynamic			
MN490	48 x 40 x 6 5/8	25000	5000	35		

WIRE MESH PARTITIONS & ENCLOSURES

Rugged Kleton wire mesh partitions and enclosures provide maximum security at a minimal cost. It is ideal for the storage of tools, valuable inventory, hazardous materials and any area of your plant where restricted access is required.

Wire mesh panels permit full visibility and allow for unrestricted circulation of air, heat and light, providing an ideal storage facility.

- 2" x 2" x 10-gauge wire mesh
- 10-gauge frame (stiffeners included on all applicable sizes)
- Pre-drilled modular components allow for quick and easy installation
- Durable Kleton blue or safety yellow finish (Other colours available)

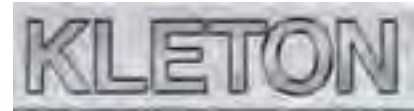

WIRE MESH PARTITION COMPONENTS

Everything necessary to create your own custom enclosure. Fast and easy assembly, multiple sizes available. Please follow these guidelines for determining the components required.

1. UNIVERSAL POSTS

A post must be placed at each end of every panel (or of every stack of panels). Be sure to calculate an extra 2" of overall wall length for each post added. When a post meets an existing wall, add one **KD115** wall bracket for proper support (fasteners are included with **KD115** to mount to post, not to wall).

Universal Posts



Blue Model No.	Yellow Model No.	Height	Wt. lbs.
KD053	KH860	8' 3"	22
KD046	KH922	10' 3"	27
KD050	KH923	12' 3"	32

2. PANELS

Whenever possible, stacking panels horizontally (one above the other) is more economical than placing them vertically (next to each other) - this is because fewer posts are required for wall support when panels are stacked.

Examples:

- For an 8' high partition, stack two **KD037** (8' x 4') panels horizontally
- For a 10' high partition, stack two **KD037** (8' x 4') and one **KD033** (8' x 2') panel horizontally
- For a 12' high partition, stack three **KD037** (8' x 4') panels horizontally

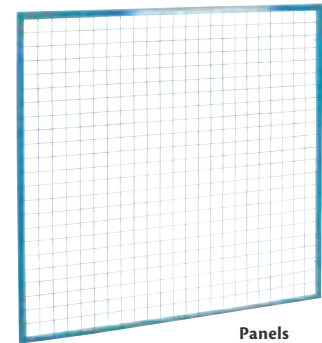

Panels



Safety Yellow

Blue Model No.	Yellow Model No.	Frame Dimensions			Wt. lbs.
		W'	x	H'	
KD121	KH926	4	x	1	10
KD120	KH927	8	x	1	21
KD030	KH928	2	x	2	10
KD031	KH929	3	x	2	11
KD032	KH914	4	x	2	12
KD033	KH915	8	x	2	31
KD034	KH916	8	x	3	40
KD035	KH930	3	x	4	20
KD036	KD130	4	x	4	23
KD037	KD131	8	x	4	45

3. ADJUSTABLE FILLER PANELS

Adjustable filler panels fill in blank spots on the ends of wire mesh partitions to plug up potential security risks. Filler panels come in two sizes: 1' x 4' and 1' x 8' that slide over the ends of existing wire mesh sections. Bolt holes on the filler panels are separated per every inch and allow the filler panel to fill in a space between 6" and 10" wide. The holes line up with holes on the existing panel which are drilled in at the top and bottom to securely fasten the filler panel in two places.

Adjustable Filler Panels



Blue Model No.	Yellow Model No.	Dimensions			Wt. lbs.
		W'	x	H'	
KD119	KH924	4	x	1	5
KD118	KH925	8	x	1	10

WIRE MESH PARTITIONS & ENCLOSURES

WIRE MESH PARTITION COMPONENTS (CONTINUED)

Everything necessary to create your own custom enclosure. Fast and easy assembly, multiple sizes available. Please follow these guidelines for determining the components required.



Customize it to your specifications. See page B71 for details.

4. SWING DOORS

HEAVY-DUTY

- Frame constructed with 1 1/4" x 1 1/4" square tube and 1" x 1" angle iron
- All are 7' in height and include a 1' transom for a total of 8' height
- May swing outwards to the left or to the right (except the KD112 and KH937 heavy swing door with wicket which swings open to the left only)
- Fasteners are included

STANDARD-DUTY

- Frame constructed with 1 1/4" x 1 1/4" angle iron frame
- All are 7' in height and include a 1' transom for a total of 8' height
- May swing outwards to the left or to the right
- Fasteners are included

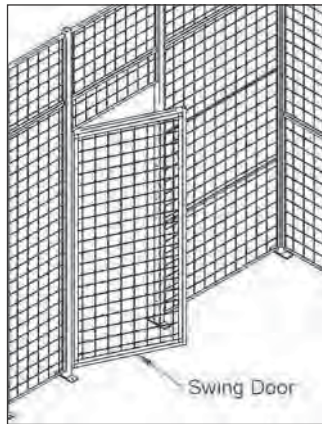

5. SLIDING DOORS

HEAVY-DUTY

- Frame constructed with 1 1/4" x 1 1/4" square tube and 1" x 1" angle iron
- All are 7' 7" in height and require one or more 8' lengths of 5" tall sliding door track, for a total of 8' height
- All sliding doors may slide open to the left or to the right
- To properly mount a sliding door, a post must be located on the side onto which the door slides, at the same distance away from the opening as the doors width

STANDARD-DUTY

- Frame constructed with 1 1/2" x 1 1/2" angle iron frame
- All are 7' 7" in height and require one or more 8' lengths of 5" tall sliding door track, for a total of 8' height
- All sliding doors may slide open to the left or to the right
- To properly mount a sliding door, a post must be located on the side onto which the door slides, at the same distance away from the opening as the doors width

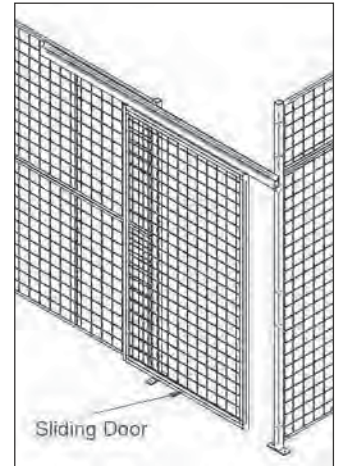

Blue Model No.	Yellow Model No.	Description	Dimensions W' x H'	Wt. lbs.
KD110	KH933	Heavy-Duty Swing Door	3 x 7	65
KH853	KH934	Standard-Duty Swing Door	3 x 7	54
KD111	KH935	Heavy-Duty Swing Door	4 x 7	74
KH854	KH936	Standard-Duty Swing Door	4 x 7	62
KD112	KH937	Heavy-Duty Swing Door w/Wicket	4 x 7	85

Blue Model No.	Yellow Model No.	Description	Dimensions W' x H'	Wt. lbs.
KH852	KH938	Standard-Duty Sliding Door	4 x 8	71
KD106	KH939	Heavy-Duty Sliding Door	4 x 8	85
KD108	KH940	Heavy-Duty Sliding Door	8 x 8	122
KD107	KH941	Heavy-Duty Sliding Door	8 x 10	148

6. HARDWARE REQUIRED

For Each Stacked Panel Add:

- 4 x MMH254, 4 x MMB721 for each 8' stacked panel
- 2 x MMH254, 2 x MMB721 for each stacked panel under 8' long

For Each Post Add:

- 8 x MMH262, 8 x MMB721, 2 x KD001 for each KD053 and KH860
- 12 x MMH262, 12 x MMB721, 2 x KD001 for each KD046 and KH922
- 12 x MMH262, 12 x MMB721, 2 x KD001 for each KD050 and KH923

For Each Sliding Door Add:

- 1 x KD028, 1 x KD029 door track for each KD106 and KH852 4' wide sliding door
- 1 x KD028, 2 x KD029 door track for each KD108 and KD107 8' wide sliding door

Blue Model No.	Yellow Model No.	Description	Wt. lbs.
KD029	KH942	8' Door Track	16
KD028	KH943	Sliding Door Hardware Kit	6
KD115	KH944	Wall Bracket Kit	0.1
MMH254*	-	5/16" x 1" Carriage Bolt	0.01
MMH262*	-	5/16" x 3" Carriage Bolt	0.01
MMB721	-	Nut 5/16" Hex	0.01
KD001	-	3/8" Anchor Bolt	0.01

* 1 x MMB721 is required for each MMH254 and MMH262.

STRIP CURTAIN DOORS

Everything you need in one package to install your own strip curtain door and save money!

ORDERING INFORMATION

Every strip curtain door comes complete with PVC strips and universal hardware for mounting strip curtain. Simple-to-follow installation instructions are included in every package.

- Determine inside width and height of door opening.
NOTE: If mounting on door above lintel, measure from floor to mounting height.
- Select type of PVC material required: STANDARD or LOW TEMP.
Standard recommended for temperatures from -23°C to 66°C.
Low Temp. recommended for interior use only for temperatures from -40°C to 66°C.
- Select from the standard sizes listed in the chart below.
NOTE: If required size is not available, order the next largest size. Installation instructions describe how simple trimming can custom fit almost any door opening.
- Special size doors and hanging applications are available upon request.
- For overhead doors, please call one of our sales representatives for assistance.

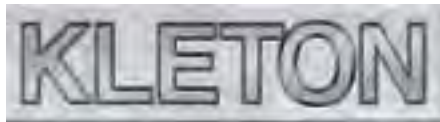

INTERIOR DOORS

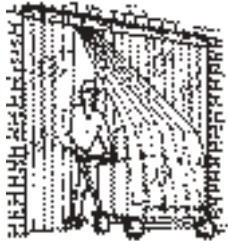

Save energy costs

- The optimal solution to open door heat/cooling loss

Reduce noise pollution

- Provides the ideal acoustical barrier around noisy equipment



Every strip curtain door comes complete with PVC strips and universal hardware for door or wall mounting. Simple-to-follow installation instructions included in every package.

EASY TO ORDER

It is easy to order the strip curtain that fits your door exactly because seven standard sizes can be made to fit 95% of most door openings. Special sizes are available.

CONVEYORS

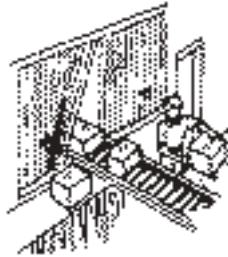

Provide extra safe passage

- People can see and be seen so there is less chance of accidents

Control smoke, dust and sprays

- Strip curtains can control in-plant contaminants to improve employee environment

DOCKS



Low maintenance

- Clear flexible vinyl resists stretching and stands up to abrasion
- All aluminum hardware is used for maximum durability
- May be quickly and easily cleaned with detergents or cleansing agents that are free from abrasives
- Deep stains and ingrained dirt can be removed by carefully applying ethanol

STANDARD DOOR SIZES

Model No. Standard	Model No. Low Temp.	Strip Dimensions	Door Opening			Wt. lbs.
			W'	x	H'	
KF022	KF004	8"	4	x	7	25
KF023	KF005	(8" x 0.080)	5	x	8	35
KF024	KF006		6	x	8	40
KF026	KF008	12"	8	x	8	80
KF025	KF007	(12" x 0.120)	8	x	10	100
KF020	KF002		10	x	10	125
KF021	KF003		12	x	12	175

Note: Doors with 8" strips have 2" standard overlap.
Doors with 12" strips have 4" standard overlap.

REPLACEMENT STRIPS - 5 PER CARTON

Model No. Standard	Model No. Low Temp.	Strip Dimensions	Wt. lbs.
KF032	KF013	8" x 0.080 x 8'	15
KF029	KF011	12" x 0.120 x 12'	45

BULK ROLLS

Model No. Standard	Model No. Low Temp.	Strip Dimensions	Colour	Roll'	Wt. lbs.
KF033	KF014	8" x 0.080	Clear	300	99
KF030	KF012	12" x 0.120	Clear	200	150
KF031	-	16" x 0.160	Clear	100	140
ML959*	-	8" x 0.080	Dark Amber	300	99

* For welding applications



CUSTOMIZE IT TO YOUR SPECIFICATIONS. SEE PAGE B71 FOR DETAILS

FIXED MOUNTING SYSTEM

Model No.	Description
KF001	Complete 4' aluminum angle mount

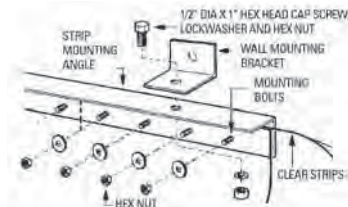

CURTAIN PARTITIONS

- Curtain partitions screen, isolate, enclose and protect any area of any size
- Commonly used in welding and paint shops, but can be used anywhere
- Brackets made of 16-gauge steel and designed for wall or ceiling mount but can be self supported by floor stands
- Large selection of drape material can be utilized with any curtain

DESIGN YOUR OWN CURTAIN

Curtains - Take exact length of area of enclosure and add 10% fullness for proper draping. Then multiply length and height to obtain square footage. Curtains hemmed on top and two sides 2" pocket on bottom side. Brass grommets spaced every 12". Refer to model number for square footage cost of fabric required.

Track - Straight and curved. Straight track available in 5' and 10' lengths. Curved corners are 3' long with 2' radius welded splicer on each end included. When using a curved track, length is increased by 2', e.g. 8' straight track with a curve at each end overall = 12'.

Carriers - Since curtains are made to any length be sure to add one additional carrier to actual length of curtain ordered. For example every 10' of curtain is fabricated with 11 grommets on top side. Therefore 11 carriers are required. A double carrier should be used at the beginning of each curtain. Steel roller carriers are permanently lubricated enclosed bearings.

Clamps - Available for flush ceiling/beam mounting and floor mounting. Clamps can also be used as track splicers. All fasten with supplied Allen bolts. Order sufficient clamps to support track every 5'. When free standing uprights are required, be sure to specify clamps for fastening track on posts **KB032** (posts are required every 8'). Other custom heights on application.

Note: All posts should be lagged or welded to floor as required.

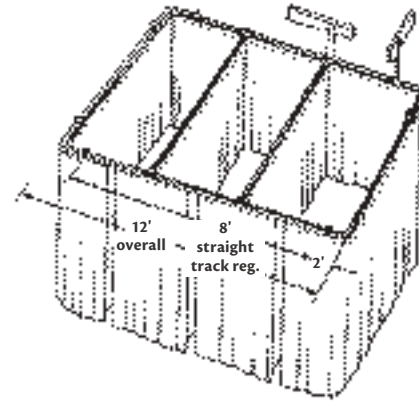

Model No.	Description
TRACKS	
KB017	5', 16 ga. Track
KB016	10', 16 ga. Track
KB029	Track Splicer
KB012	End Stop
ROLLERS	
KB013	Single Nylon Roller 25 lbs., Cap. 2 1/2" Hook
KB018	Single Steel Roller 75 lbs., Cap. 2 1/2" Hook
KB019	Double Steel Roller 125 lbs., Cap. 2 1/2" Hook
KB014	Overlap By-Pass Roller 12" Long x 2 3/4" High
WALL MOUNTS	
KB020	Wall Connector Bracket, Down
KB021	Wall Connector Bracket, Up
KB011	End Connector Fastener, Up
KB010	End Connector Fastener, Down

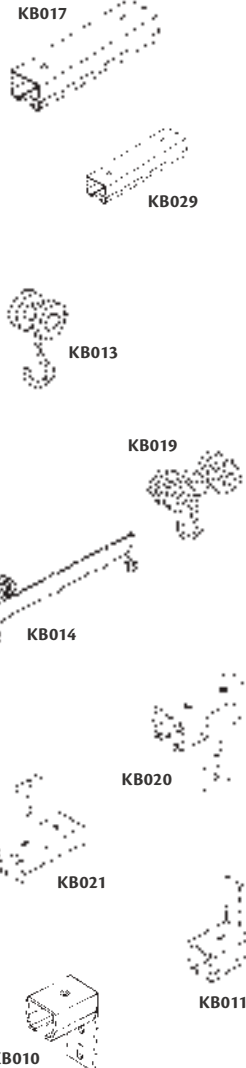

Model No.	Description
CURTAIN	
KB040	10 oz/sq.yd., Before Treatment Cotton Duck, Flame Resistant Army Green
KB004	14 mil Yellow PVC, Flame Resistant
KB003	14 mil Green PVC, Flame Resistant
KB038	20 mil Clear PVC, Flame Resistant

Other colours are available

Model No.	Description
FLOOR MOUNTS	
KB009	3' 90° Curve Track
KB025	Track Splicer
KB027	90° Corner Connector
KB024	3-Way T-Connector
KB032	8' Square Post
KB005	12" x 12" Base
BEAM MOUNTS/SUSPENSION	
KB008	3' 90° Curve Track
KB031	Ceiling Clamp
KB028	90° Corner Connector
KB023	3-Way T-Connector
CEILING MOUNTS	
KB007	3' 90° Curve Track, Three Flush Connectors
KB030	Track Splicer
KB026	90° Corner Connector
KB022	3-Way T-Connector

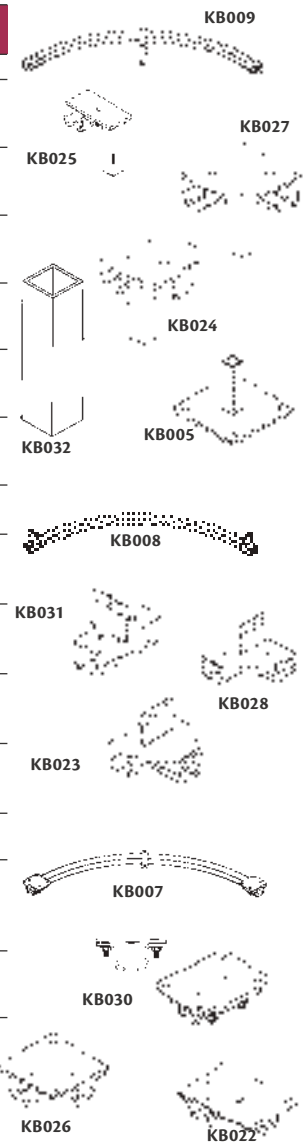

SECURITY GATES & PROTECTORS

SOFT EDGE FLEXIBLE WARNING & PROTECTION SYSTEMS

- Tough, flexible polyurethane foam extrusions reduce the risk of personnel injury at high risk corners
- When applied to machinery, furnishings and walls, Soft Edge prevents impact damages by absorbing even the hardest of impacts
- Highly visible black and yellow markings offer permanent warning in dangerous areas
- Simple "peel-away" adhesive installation on grease-free surfaces
- Excellent temperature range from -40°C to 100°C



Style	Model No. 1 Metre	Model No. 5 Metres
A	KH866	KH865
B	KH868*	KH867*
C	KH870	KH869
D	KH872	KH871
E	KH952	KH953
F	KH954	KH955
G	KH956*	KH957*
H	KH958	KH959

*Held by pressure fit, not peel-away adhesive

COLUMN PROTECTORS

- Protect your building's columns from damaging bumps by moving vehicles
- 100% rust proof material, linear low density polyethylene (LLDPE)
- Octagon configuration for more rebounding ability
- Flexible deflection design - capable of handling a hit from a 7000-lb forklift at 6 mph
- Easy to assemble, nylon fasteners (included) for breakaway ability make these extremely versatile
- Protect columns under virtually any condition and temperature down to 0°F
- Dimensions: 22" L x 22" W x 40" H
- Weight: 42 lbs.



Model No.	Inside Opening"	Opening Shape
RN049	9	Round
RN051	8 x 10	Rectangular
RN048	8	Square
RN052	12	Square
RN050	10	Square
RN047	6	Square

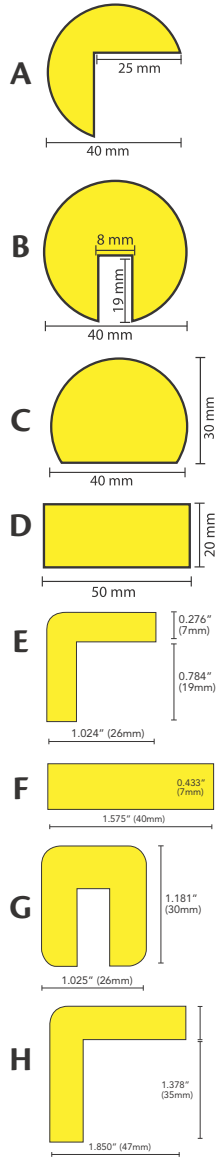

POLYETHYLENE BOLLARD COVERS

- Enhance and protect the appearance of your steel bollards
- Reduce maintenance; avoid scraping and painting each spring
- Constructed of 1/8" UV stable polyethylene for durability
- Easy installation with patented GripperTabs™ included
- Colour: Safety yellow with reflective red tape or high visibility red with white reflective tape, for great visibility day or night
- 5-year warranty against fading and cracking



Yellow Model No.	Red Model No.	Fits Bollard Diameter"	Fits Bollard Length"	Wt. lbs.
KH806	KH836	4.5	52	7
KH808	KH838	4.5	64	9
KH809	KH839	6.6	52	8
KH810	KH840	6.6	60	9
KH811	KH841	6.6	72	10

GALVANIZED FOLDING SECURITY GATES

- Secure outside access during the day and add security at night with heavy-duty, 14-gauge steel folding gates
- Constructed of galvanized steel U-channels riveted using aircraft quality rivets for durability
- Double folding gates centre drop pin rests in your pre-drilled holes to secure gate when extended
- Locks can be located on right or left side of single gates
- Durable 3" rubber casters that fully retract when not in use
- Installation hardware included



SINGLE FOLDING GATES

Lock Location		Usable Width'	Collapsed Height'	Expanded Height'	Wt. lbs.
Left Model No.	Right Model No.				
KA035	KA036	3 to 4	6.5	6	69
KA037	KA038	3 to 4	7	6.5	73
KA039	KA040	3 to 4	7.5	7	77
KA041	KA042	3 to 4	8	7.5	80
KA043	KA044	3 to 4	8.5	8	84
KA065	KA066	6 to 7	6.5	6	82
KA067	KA068	6 to 7	7	6.5	85
KA069	KA070	6 to 7	7.5	7	87
KA071	KA072	6 to 7	8	7.5	90
KA073	KA074	6 to 7	8.5	8	92
KA085	KA086	8 to 9	7	6.5	102
KA087	KA088	8 to 9	7.5	7	104
KA089	KA090	8 to 9	8	7.5	106

DOUBLE FOLDING GATES

Model No.	Usable Width'	Collapsed Height'	Expanded Height'	Wt. lbs.
KA001	8 to 10	6.5	6	144
KA002	8 to 10	7	6.5	148
KA003	8 to 10	7.5	7	153
KA004	8 to 10	8	7.5	158
KA005	8 to 10	8.5	8	162
KA006	10 to 12	6.5	6	168
KA007	10 to 12	7	6.5	172
KA008	10 to 12	7.5	7	177
KA009	10 to 12	8	7.5	182
KA010	10 to 12	8.5	8	187
KA011	12 to 14	6.5	6	180
KA012	12 to 14	7	6.5	184
KA013	12 to 14	7.5	7	189
KA014	12 to 14	8	7.5	196
KA015	12 to 14	8.5	8	199
KA016	14 to 16	6.5	6	192
KA017	14 to 16	7	6.5	196
KA018	14 to 16	7.5	7	199
KA019	14 to 16	8	7.5	201
KA020	14 to 16	8.5	8	206
KA021	16 to 18	7	6.5	204
KA022	16 to 18	7.5	7	208
KA023	16 to 18	8	7.5	211

SAFETY GUARDS & BOLLARDS

PERIMETER GUARDS

- Create your own barrier guards with two styles to choose from: 2" x 2" welded wire mesh or 2" square tube
- Both feature a unique 49 1/2" overall height, and are easily installed
- Posts are constructed of 2" square tube with 5/16" base plate with holes for anchoring to floor
- Hardware to attach add-on sections is included
- Safety yellow or Kleton blue finish



MESH STYLE KITS

Blue Model No.	Yellow Model No.	Description	Dimensions			Wt. lbs.
			W"	x	H"	
KH945	RL848	Starter Section	48	x	48	46
KH946	RL849	Add-On Section	48	x	48	46
KH947	RL850	Starter Section	96	x	48	65
KH948	RL851	Add-On Section	96	x	48	65

Note: Includes assembly fasteners, floor anchors and post caps

MESH STYLE INDIVIDUAL COMPONENTS

Blue Model No.	Yellow Model No.	Description	Dimensions			Wt. lbs.
			W	x	H	
KD036	KD130	Mesh Panel	4'	x	4'	20
KD037	KD131	Mesh Panel	8'	x	4'	39
KH861	KD129	Post Universal	49 1/2" H			13

HARDWARE REQUIRED

KD001	Floor Anchors (Two per Post)
MMH262	5/16" x 3" Carriage Bolt (Four per Frame)
MMB721	5/16" Hex Nut (One Nut for Each MMH262)
KD116	Post Caps (One per Post)

TUBULAR STYLE

Model No.	Description	Dimensions			Wt. lbs.
		W"	x	H"	
KD132	Starter Section	48	x	49 1/2	45
KD133	Add-On Section	48	x	49 1/2	32
KD134	Starter Section	96	x	49 1/2	66
KD135	Add-On Section	96	x	49 1/2	53

HARDWARE REQUIRED

KD001	Floor Anchors (Four per Starter Section / Two per Add-On Section)
KD116	Post Caps (One per Post)

SAFETY GUARDS

- Protect your equipment and personnel from accidental damage and injury with these low profile safety guards
- 4" x 4" square tube welded to an 8" x 8" x 1/2" base, complete with four 3/4" diameter holes for anchoring to floor
- Safety yellow powder coat finish

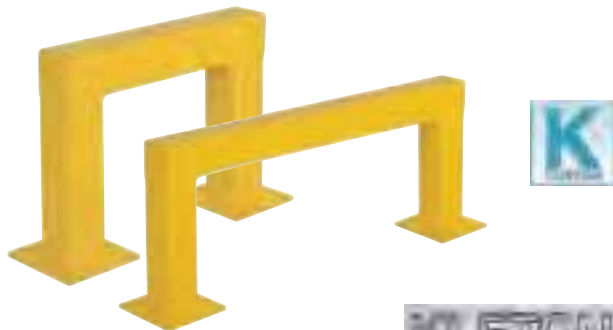

CUSTOMIZE IT TO YOUR SPECIFICATIONS.
SEE PAGE B71 FOR DETAILS

Model No.	Dimensions			Wt. lbs.
	W"	x	H"	
KD127	24	x	18	65
KH855	36	x	18	75
KD128	48	x	18	85
KD136	24	x	42	95
KD856	36	x	42	110
KD139	48	x	42	115

UPRIGHT PROTECTORS

- Protects industrial racking from damaging impacts that cause unsafe conditions
- Made from 1/4" thick steel
- Four pre-drilled holes made for 1/2" anchors (not included)
- Safety yellow powder coat finish



Model No.	Dimensions				Wt. lbs.	
	W"	x	D"	x	H"	
KH858	7	x	7	x	12	12
RB925	7	x	7	x	18 1/4	15

HEAVY-DUTY STEEL BOLLARDS

- Protect your warehouse equipment, as well as high traffic areas with these heavy-duty steel bollards
- 4" x 4" square tube welded to an 8" x 8" x 1/2" steel base, complete with four 3/4" diameter holes for anchoring to floor
- Safety yellow powder coat finish

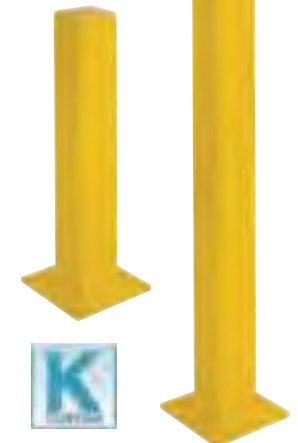

Model No.	Height"	Wt. lbs.
KD125	24	30
KH857	36	40
KD126	48	50